

The image is a product catalog cover for outdoor cabinets. It features a dark green background with a large, semi-transparent white triangle on the right side. In the foreground, there are two cabinets: one is orange and the other is dark green. The orange cabinet is in the lower-left foreground, and the dark green cabinet is in the lower-right foreground. The dark green cabinet is shown with its door open, revealing a white interior panel. The orange cabinet is shown with its door closed. The text 'Product catalog' is written in white, and 'Outdoor Cabinets' is written in a larger, bold white font. The CONTEG logo is at the bottom center.

Product catalog

Outdoor Cabinets

CONTEG



WE ARE CONTEG

Leading Producer of **IT, Data Center, and Industrial Solutions**

Since its founding in 1998, CONTEG has continued its constant development and growth. Today, we are one of the leading manufacturers of complete solutions for data centers, telecommunication cabinets, and industrial cabinets.

We provide a global sales and technical support, have manufacturing plants equipped with latest technologies, and also operate a data center testing laboratory.

We supply our solutions to small businesses, large corporations as well as industrial customers.



CONTEG

IN NUMBERS

Year of foundation: 1998

International branches and showrooms: 10

Partners: in 60 countries on 3 continents

Headquarters: Prague, Czech Republic

Production plant and central warehouse: Pelhrimov, Czech Republic



Production plant and central warehouse: Pelhrimov, Czech Republic

CONTENTS

OUTDOOR CABINETS	5
outTEG OMR—FREE-STANDING CABINETS	6
Main advantages and description	8
Interior installation	14
Accessories	19
RAMOS monitoring system	20
Climate control solution—outdoor cooling units	22
Climate control solution—cooling and heating	24
Technical drawings	27
Heat loss dispersion	28
outTEG OMR LITE—POLE OR WALL MOUNTED CABINETS	30
Main advantages and description	32
Accessories	34
Climate control solution—cooling and heating	40
Technical drawings	43
Heat loss dispersion	43
FSM-O—FREE-STANDING COMPACT STAINLESS STEEL CABINETS	44
Main advantages and description	46
Accessories	49
Climate control solution—filter fans	57
Climate control solution—cooling units	58
Climate control solution—cooling units airflow	60
Technical drawings	61
Heat loss dispersion	62
WME-O—COMPACT STAINLESS STEEL CABINETS	64
Main advantages and description	66
Accessories	68
Climate control solution—filter fans	74
Technical drawings	75
Heat loss dispersion	77

OUTDOOR CABINETS

➤ The advantage of double-walled aluminum cabinets is that it maintains a 10 % lower internal temperature than a plastic or single-walled solution. In many applications, our customers do not have to invest in air-conditioning units at all, or they can save them by lowering the power of these devices and consequently the energy consumed for their operation.

You can order cabinets from our standard ranges to ensure quick delivery. If you have special requirements, you can design these cabinets according to your specifications. You can use our web configurator or contact our experienced sales representatives.

	outTEG OMR	outTEG OMR LITE	FSM-O	WME-O
				
	(see page 6)	(see page 30)	(see page 44)	(see page 64)
Material	Door, rear panel, roof—aluminum Frame, plinth—stainless steel	Aluminum	Stainless steel	Stainless steel
Construction	Double-walled	Double-walled	Single-walled	Single-walled
IP rating	IP65	IP65	IP55	IP66
Mechanical protection	IK10	IK10	IK10	IK10
Color	RAL 7035 (light grey) for body RAL 7046 (grey) for roof and plinth	RAL 7035 (light grey)	RAL 7035 (light grey)	RAL 7035 (light grey)
Coating	Polyester powder coating with UV protection	Polyester powder coating with UV protection	Polyester powder coating with UV protection	Polyester powder coating with UV protection



outTEG OMR—
FREE-STANDING
OUTDOOR CABINETS

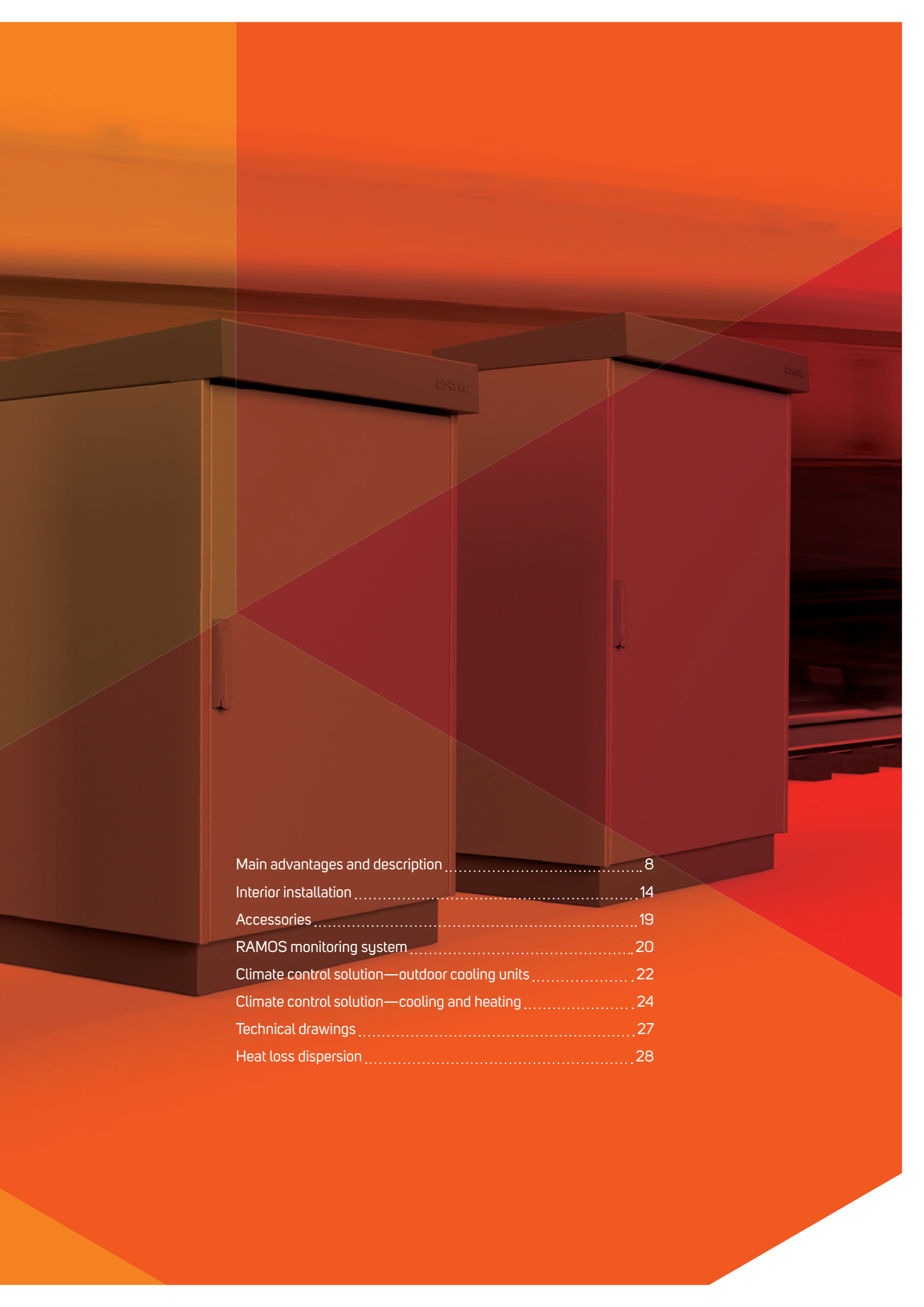

Main advantages and description	8
Interior installation	14
Accessories	19
RAMOS monitoring system	20
Climate control solution—outdoor cooling units	22
Climate control solution—cooling and heating	24
Technical drawings	27
Heat loss dispersion	28



OMR-DN-106506-R

➤ The outTEG OMR free-standing outdoor cabinets presents an ideal solution for projects with high demands on safety of installed equipment and on stable in-rack climate. Double-walled case design safeguards the installed components from all-weather as well as from vandalism thanks to the cabinet's compact structure which prevents access to the installed components from the outside. For extreme weather conditions, the side panel variants can be modified to allow the installation of fans or air-conditioning units. Resistance to weather is ensured mainly by the AlMg3 alloy used for the cabinet case and the applied finish of polyester powder coating with UV protection. Additional protection is provided by the stainless steel frame and the plinth.

MAIN ADVANTAGES

- Features integrated roof and plinth
- Welded stainless steel cabinet frame
- All removable parts are made of aluminum
- Compact design—no point of access for lever-type tools
- Ready for crane transport

COLOR:  RAL 7035  RAL 7046



DESCRIPTION

Material

- Door, rear/side panels, roof—2 mm AlMg3
- Frame, plinth—2 mm stainless steel 1.4016 (AISI 403)

Coating

- Polyester powder coating with UV protection

Color

- Body color—RAL 7035
- Roof and plinth color—RAL 7046

IP rating

- IP66 (degree of IP rating can be reduced after mounting some accessories)

Seismic protection

- Seismic approvals according to Bellcore GR-63-CORE Zone 3 (Zone 4 upon request)

Package includes

- Double-walled outdoor cabinet, fully mounted

- Ventilation—natural air flow between inner and outer walls
- Removable rear panel
- Removable roof
- Front door with multi-point locking system, key combination 333, door stop. Easily configured to a right or left hand door mounting
- 100 mm plinth
- Vertical mounting internal rails with 25 mm perforations

- Removable gland plate
- Set-up for eye-bolts
- Side panels need to be ordered separately (see page 10)

outTEG OMR— FREE-STANDING OUTDOOR CABINETS, DOUBLE-WALLED, SINGLE DOOR, HEIGHT 600–1 200 mm							
H (U)	Package	12 U	16 U	21U	21U	25 U	25 U
H (mm)		600	800	1000	1000	1200	1200
W (mm)		650	650	650	800	800	1000
D (mm)		600	600	600	500	800	700
Weight (kg)		63	69	81	82	115	119
Code	1 pc	OMR-DN-066506-R	OMR-DN-086506-R	OMR-DN-106506-R	OMR-DN-100805-R	OMR-DN-120808-R	OMR-DN-121007-R
ACCESSORIES							
Side panel **	1 pc	OMR-DN-S0606-1	OMR-DN-S0806-1	OMR-DN-S1006-1	OMR-DN-S1005-1	OMR-DN-S1208-1	OMR-DN-S1207-1
Mounting plate, full installation	1 pc	IDO-MM-F665	IDO-MM-F865	IDO-MM-F1065	IDO-MM-F108	IDO-MM-F128	IDO-MM-F1210
19" and 21" vertical rails	1 pair	IDO-MR-V6	IDO-MR-V8	IDO-MR-V10	IDO-MR-V10	IDO-MR-V12	IDO-MR-V12
ETSI vertical rails	1 pair	IDO-MR-E6	IDO-MR-E8	IDO-MR-E10	IDO-MR-E10	IDO-MR-E12	IDO-MR-E12
N profile for vertical rails	1 pair	IDO-MR-N6 *	IDO-MR-N6 *	IDO-MR-N6 *	IDO-MR-N5 *	IDO-MR-N8 *	–
L profile for vertical rails	1 set	–	–	–	IDO-MR-L5	IDO-MR-L8	IDO-MR-L7
Horizontal rail	1 pair	see page 16					
Baying kit	1 set	OMR-DN-K0606	OMR-DN-K0806	OMR-DN-K1006	OMR-DN-K1005	OMR-DN-K1208	OMR-DN-K1207
Fixing frame for concrete base	1 pc	IDO-MF-P6506	IDO-MF-P6506	IDO-MF-P6506	IDO-MF-P0805	IDO-MF-P0808	IDO-MF-P1007

* You have to order 2 sets, for 1400 a 1600 mm height must be ordered 3 sets. For 800 mm wide cabinets with IDO-MR-Nxx, an IDO-MR-N-B holder (2 sets for 1 set of IDO-MR-Nxx) must be ordered as well.

outTEG OMR— FREE-STANDING OUTDOOR CABINETS, DOUBLE-WALLED, SINGLE DOOR, HEIGHT 1 400–1 600 mm							
H (U)	Package	30 U	34 U	34 U	34 U	34 U	34 U
H (mm)		1400	1600	1600	1600	1600	1600
W (mm)		650	650	800	800	1000	1000
D (mm)		600	400	700	1000	800	800
Weight (kg)		91	97	107	124	169	169
Code	1 pc	OMR-DN-146506-R	OMR-DN-166504-R	OMR-DN-160807-R	OMR-DN-160810-R	OMR-DN-161008-R	OMR-DN-161008-R
ACCESSORIES							
Side panel **	1 set	OMR-DN-S1406-1	OMR-DN-S1604-1	OMR-DN-S1607-1	OMR-DN-S1610-1	OMR-DN-S1608-1	OMR-DN-S1608-1
Mounting plate, full installation	1 pc	IDO-MM-F1465	IDO-MM-F1665	IDO-MM-F168	IDO-MM-F168	IDO-MM-F1610	IDO-MM-F1610
19" and 21" vertical rails	1 pair	IDO-MR-V14	IDO-MR-V16	IDO-MR-V16	IDO-MR-V16	IDO-MR-V16	IDO-MR-V16
ETSI vertical rails	1 pair	IDO-MR-E14	IDO-MR-E16	IDO-MR-E16	IDO-MR-E16	IDO-MR-E16	IDO-MR-E16
N profile for vertical rails	1 pair	IDO-MR-N6 *	IDO-MR-N4 *	IDO-MR-N7 *	IDO-MR-N10 *	–	–
L profile for vertical rails	1 set	–	–	IDO-MR-L7	IDO-MR-L10	IDO-MR-L8	IDO-MR-L8
Horizontal rail	1 pair	see page 16					
Baying kit	1 set	OMR-DN-K1406	OMR-DN-K1604	OMR-DN-K1607	OMR-DN-K1610	OMR-DN-K1608	OMR-DN-K1608
Fixing frame for concrete base	1 pc	IDO-MF-P6506	IDO-MF-P6504	IDO-MF-P0807	IDO-MF-P0810	IDO-MF-P1008	IDO-MF-P1008

* You have to order 2 sets, for 1400 a 1600 mm height must be ordered 3 sets. For 800 mm wide cabinets with IDO-MR-Nxx, an IDO-MR-N-B holder (2 sets for 1 set of IDO-MR-Nxx) must be ordered as well. ** You have to order 2 pcs.

SIDE PANELS—plain panel and ready for AC units installation



Plain side panel	Side panel, internal part, ready for modifications*	Side panel, external part, ready for modifications*	Cabinet dimensions H × D (mm)	Package
OMR-DN-S0606-1	OMR-DCMI-S0606	OMR-DCME-S0606	600 × 600	1 pc
OMR-DN-S0806-1	OMR-DCMI-S0806	OMR-DCME-S0806	800 × 600	1 pc
OMR-DN-S1005-1	OMR-DCMI-S1005	OMR-DCME-S1005	1000 × 500	1 pc
OMR-DN-S1006-1	OMR-DCMI-S1006	OMR-DCME-S1006	1000 × 600	1 pc
OMR-DN-S1207-1	OMR-DCMI-S1207	OMR-DCME-S1207	1200 × 700	1 pc
OMR-DN-S1208-1	OMR-DCMI-S1208	OMR-DCME-S1208	1200 × 800	1 pc
OMR-DN-S1406-1	OMR-DCMI-S1406	OMR-DCME-S1406	1400 × 600	1 pc
OMR-DN-S1604-1	OMR-DCMI-S1604	OMR-DCME-S1604	1600 × 400	1 pc
OMR-DN-S1607-1	OMR-DCMI-S1607	OMR-DCME-S1607	1600 × 700	1 pc
OMR-DN-S1608-1	OMR-DCMI-S1608	OMR-DCME-S1608	1600 × 800	1 pc
OMR-DN-S1610-1	OMR-DCMI-S1610	OMR-DCME-S1610	1600 × 1000	1 pc

* Needs to be ordered together as a set.

- Application: for assembling with outdoor cabinets OMR-DN-xxxxxx-R
- Double-walled construction
- Material: 2 mm AlMg3
- Color: RAL 7035
- OMR-DN-Sxxxx-1 plain side panel, for cabinets without climate solution you need 2 pcs, IP66
- OMR-DCMI-Sxxxx and OMR-DCME-Sxxxx plus cutouts in CONTEG Modification Center are ready for installation of cooling unit, IP56
For complete solution with cooling unit AC-WMO you still have to order 1 pc of OMR-DN-Sxxxx-1
- For more information about cooling units, please visit page 22
- Package includes: assembly parts, variants of side panels

SIDE PANELS—with AC unit



	Code	Description	Page
1	OMR-DCME-Sxxxx	Side panel, external part, ready for modifications	10
2	OMR-DCMI-Sxxxx	Side panel, internal part, ready for modifications	10
3	AC-WMO-xx-xxxx	Outdoor cooling unit	22

SIDE PANELS—with forced ventilation



- Application: for assembling with cabinets OMR-DN-xxxxxx-R
- Double-walled construction
- Material: 2 mm AlMg3
- Color: RAL 7035 (light grey, with UV protection for outdoor use)
- OMR-DV-Sxxxx assembled side panels (pair) with forced ventilation 180 m³/h, 230 ACV (one side with filter fan and thermostat for cooling, and second one with outlet grid), IP55
- Package includes: assembly parts, variants of side panels

Side panels with filter fan and outlet grid	Outdoor cabinet dimensions H × D (mm)	Package *
OMR-DV-S0606	600 × 600	1 set
OMR-DV-S0806	800 × 600	1 set
OMR-DV-S1005	1000 × 500	1 set
OMR-DV-S1006	1000 × 600	1 set
OMR-DV-S1207	1200 × 700	1 set
OMR-DV-S1208	1200 × 800	1 set
OMR-DV-S1406	1400 × 600	1 set
OMR-DV-S1604	1600 × 400	1 set
OMR-DV-S1607	1600 × 700	1 set
OMR-DV-S1608	1600 × 800	1 set
OMR-DV-S1610	1600 × 1000	1 set

* 1 set—2 pcs.

PERFORATED ROOF



- Application: assembled with OMR-DN-xxxxxx-R cabinets
- Material: 2 mm AlMg3
- Color: RAL 7046 (dark grey, with UV protection for outdoor use)
- Package includes: assembly parts

Forced ventilation: perforated roof + ventilation units + modification cover with outlet grid

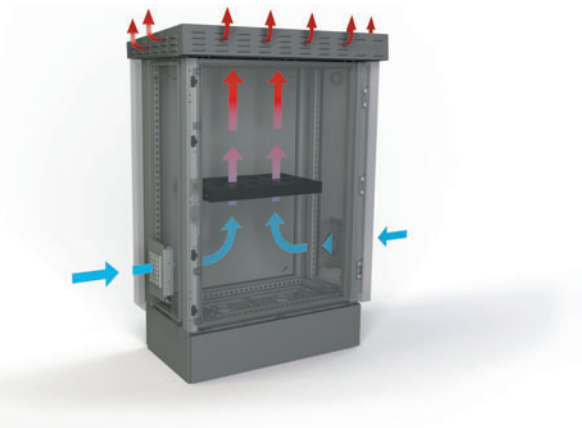

Ventilation with 19" units + modification cover with outlet grid



PERFORATED ROOF		
Code	For outdoor cabinet dimensions W × D (mm)	Package
OMR-DV-R6504	650 × 400	1 set
OMR-DV-R6506	650 × 600	1 set
OMR-DV-R0805	800 × 500	1 set
OMR-DV-R0807	800 × 700	1 set
OMR-DV-R0808	800 × 800	1 set
OMR-DV-R0810	800 × 1000	1 set
OMR-DV-R1007	1000 × 700	1 set
OMR-DV-R1008	1000 × 800	1 set

SIDE PANELS WITH OUTLET GRID—FOR VENTILATION IN ROOF		
Code	For outdoor cabinet dimensions H × D (mm)	Package *
OMR-DV-S1005-54	1000 × 500	1 set
OMR-DV-S1207-54	1200 × 700	1 set
OMR-DV-S1208-54	1200 × 800	1 set
OMR-DV-S1406-54	1400 × 600	1 set
OMR-DV-S1604-54	1600 × 400	1 set
OMR-DV-S1607-54	1600 × 700	1 set
OMR-DV-S1608-54	1600 × 800	1 set
OMR-DV-S1610-54	1600 × 1000	1 set

* 1 set—2 pcs.

CUSTOMIZED SOLUTIONS FOR outTEG OMR

➤ If you don't choose from our basic series, you can design your own outdoor cabinet according to specific requirements.

Use our web configurator <https://partner.conteg.com/en/outteg/step1> or contact with our experienced sales representatives, who will gladly help you.

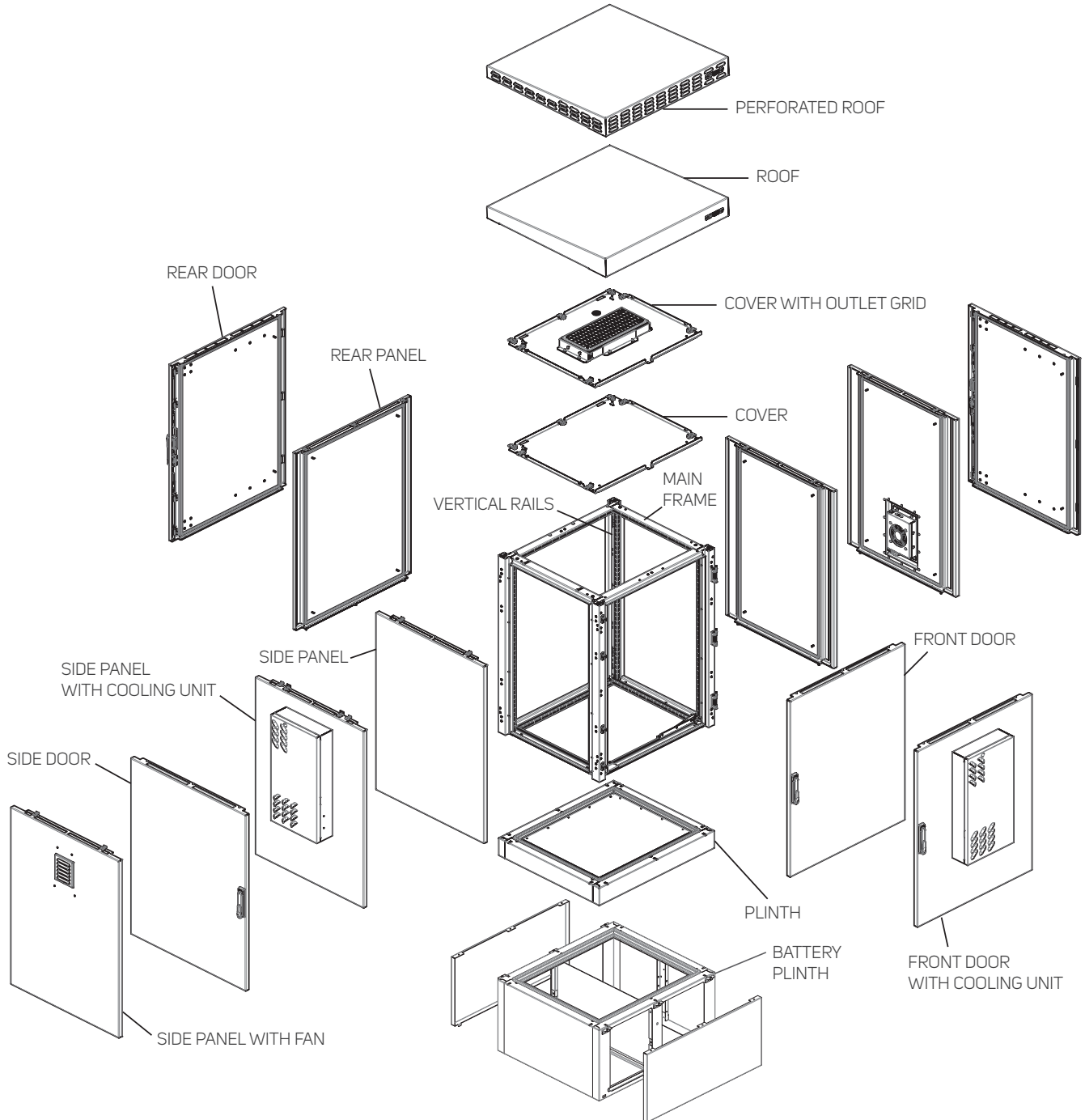

EXAMPLE OF CUSTOMIZED SOLUTIONS FOR outTEG OMR

➤ Support for natural ventilation between the inner and outer walls with roof mounted fans.



INTERIOR INSTALLATION

19", 21" AND ETSI VERTICAL RAILS

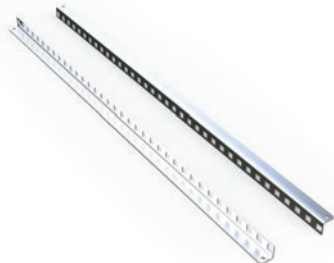

- Application: in combination with N or L profiles
- Material: 2 mm galvanized sheet steel
- Installation: on IDO-MR-Nxx/IDO-MR-Lxx rails
- Package includes: assembly parts

Code (19", 21")	Code (ETSI)	For cabinet height mm (in U)	Package *
IDO-MR-V6	IDO-MR-E6	600 (12U)	1 set
IDO-MR-V8	IDO-MR-E8	800 (16U)	1 set
IDO-MR-V10	IDO-MR-E10	1000 (21U)	1 set
IDO-MR-V12	IDO-MR-E12	1200 (25U)	1 set
IDO-MR-V14	IDO-MR-E14	1400 (30U)	1 set
IDO-MR-V16	IDO-MR-E16	1600 (34U)	1 set

* 1 set—2 pcs.

N PROFILE FOR VERTICAL RAILS

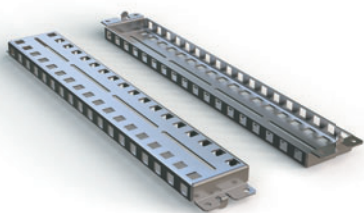

- Application: for 650 and 800 ** mm cabinet widths
- Material: 2 mm galvanized sheet steel
- Installation: on the frame profile
- Package includes: assembly parts

Code	For cabinet depth (mm)	Package *
IDO-MR-N4	400	1 set
IDO-MR-N5	500	1 set
IDO-MR-N6	600	1 set
IDO-MR-N7	700	1 set
IDO-MR-N8	800	1 set
IDO-MR-N10	1000	1 set

* 1 set—2 pcs.

** You have to order 2 sets, for 1400 and 1600 mm heights must be ordered 3 sets.

For 800 mm wide cabinets with IDO-MR-Nxx, an IDO-MR-N-B holder (2 sets for 1 set of IDO-MR-Nxx) must be ordered as well.

L PROFILE FOR VERTICAL RAILS

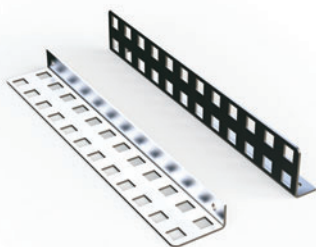

- Application: for 800 and 1000 mm cabinet widths
- Material: 2 mm galvanized sheet steel
- Installation: on the frame profile
- Package includes: assembly parts

Code	For cabinet depth (mm)	Package *
IDO-MR-L5	500	1 set
IDO-MR-L7	700	1 set
IDO-MR-L8	800	1 set
IDO-MR-L10	1000	1 set

* 1 set – 4 pcs.

TYPICAL MOUNTING OPTIONS FOR outTEG OMR

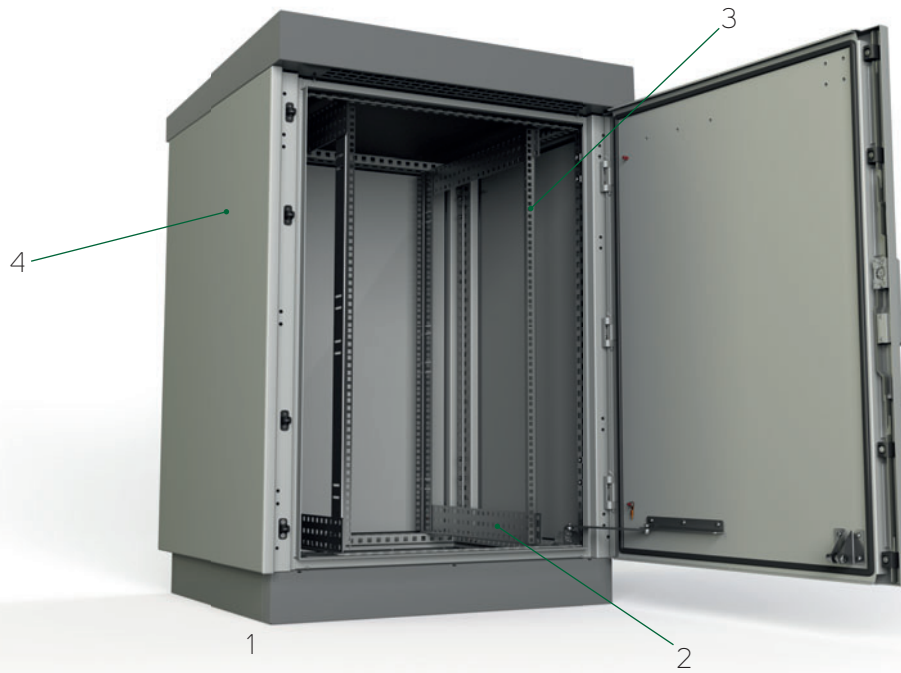

	Code	Description	Page
1	OMR-DN-xxxxxx-R	Outdoor cabinet	9
2	IDO-MR-Lx	L profile for 19" vertical rails (1 set)	14
3	IDO-MR-Vx	Vertical rails (1 set for front and 2 sets for front and rear 19" extrusions)	14
4	OMR-DN-Sxxxx-1	Plain side panels (2 pcs)	10

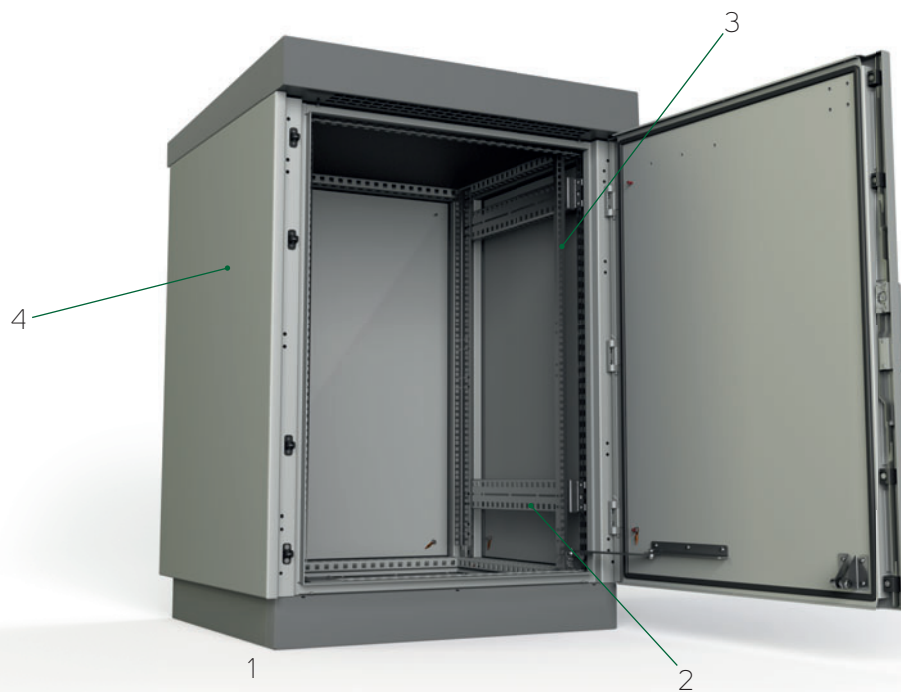

	Code	Description	Page
1	OMR-DN-xxxxxx-R	Outdoor cabinet	9
2	IDO-MR-Nx	N profile for 19" vertical rails (2-3 sets depends on height of cabinet)	14
3	IDO-MR-Vx	Vertical rails (1 set for front and 2 sets for front and rear 19" extrusions)	14
4	OMR-DN-Sxxxx-1	Plain side panels (2 pcs)	10

HORIZONTAL AND VERTICAL RAILS

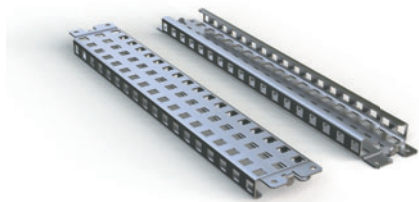

- Application: for additional mounting positions
- Material: 2 mm galvanized sheet steel
- Installation: on the frame profile
- Package includes: assembly parts



MOUNTING PLATE



- Application: possibility to combine with 19" extrusions
- Material: 3 mm galvanized sheet steel
- Package includes: assembly parts

VERTICAL RAIL FOR CABINET HEIGHT

Code	For cabinet H (mm)	Load (kg)	Package *
IDO-MR-HH6	600	240	1 set
IDO-MR-HH8	800	180	1 set
IDO-MR-HH10	1000	140	1 set
IDO-MR-HH12	1200	120	1 set
IDO-MR-HH14	1400	80	1 set
IDO-MR-HH16	1600	80	1 set

HORIZONTAL RAIL FOR CABINET WIDTH

Code	For cabinet W (mm)	Load (kg)	Package *
IDO-MR-HW65	650	70	1 set
IDO-MR-HW8	800	50	1 set
IDO-MR-HW10	1000	50	1 set

HORIZONTAL RAIL FOR CABINET DEPTH

Code	For cabinet D (mm)	Load (kg)	Package *
IDO-MR-H4	400	140	1 set
IDO-MR-H5	500	100	1 set
IDO-MR-H6	600	70	1 set
IDO-MR-H7	700	60	1 set
IDO-MR-H8	800	50	1 set
IDO-MR-H10	1000	50	1 set

* 1 set—2 pcs.

Code For cabinet size H×W (mm) Package

Code	For cabinet size H×W (mm)	Package
IDO-MM-F665	600 × 650	1 pc
IDO-MM-F865	800 × 650	1 pc
IDO-MM-F1065	1000 × 650	1 pc
IDO-MM-F108	1000 × 800	1 pc
IDO-MM-F128	1200 × 800	1 pc
IDO-MM-F1210	1200 × 1000	1 pc
IDO-MM-F1465	1400 × 650	1 pc
IDO-MM-F1665	1600 × 650	1 pc
IDO-MM-F168	1600 × 800	1 pc
IDO-MM-F1610	1600 × 1000	1 pc

BAYING KIT



- Baying kit for assembling of cabinets in row
- Application: for assembling with OMR-DN-xxxxxx-R cabinets
- Double-walled construction
- Material: 2 mm AlMg3
- Protection degree of assembled cabinets: IP55
- Color: RAL 7035 (light grey, with UV protection for outdoor use)
- Package includes: assembly parts

Code	For cabinet size HxD (mm)	Package
OMR-DN-K0606	600 × 600	1 set
OMR-DN-K0806	800 × 600	1 set
OMR-DN-K1005	1000 × 500	1 set
OMR-DN-K1006	1000 × 600	1 set
OMR-DN-K1207	1200 × 700	1 set
OMR-DN-K1208	1200 × 800	1 set
OMR-DN-K1406	1400 × 600	1 set
OMR-DN-K1604	1600 × 400	1 set
OMR-DN-K1607	1600 × 700	1 set
OMR-DN-K1608	1600 × 800	1 set
OMR-DN-K1610	1600 × 1000	1 set



FIXING FRAME FOR CAST CONCRETE BASE



- Fixing frame for right position and installation of outTEG cabinet
- Application: for assembling with both series of outTEG cabinets
- Welded frame with anchors and screws
- Material: 4 mm galvanized sheet steel
- Package includes: assembly parts

Code	For cabinet sizes W×D (mm)	Package
IDO-MF-P6504	650 × 400	1 set
IDO-MF-P6506	650 × 600	1 set
IDO-MF-P0805	800 × 500	1 set
IDO-MF-P0807	800 × 700	1 set
IDO-MF-P0808	800 × 800	1 set
IDO-MF-P0810	800 × 1000	1 set
IDO-MF-P1007	1000 × 700	1 set
IDO-MF-P1008	1000 × 800	1 set



ACCESSORIES

DOOR SWITCH



- Material of bracket: 2 mm zinc-plated sheet steel
- Door switch: IP65, plastic, 1NO + 1NC, PG13,5, -25 °C to +70 °C
- Rated current: 10 A/250 VAC
- Plug: grey ST 17/2
- Supply cable: 1 m, 2G 1,0 mm²
- Package includes: door switch and all necessary assembly parts

Code	Package
IDO-DC	1 pc

POCKET FOR DOCUMENTS



- Material: ABS
- Color: RAL 7035
- Dimensions: 234 × 241 × 31 mm (H × W × D)
- Mounting: with self-adhesive tape
- Package includes: plastic pocket for documents and adhesive tape

Code	Package
ID-PO-A4	1 pc

LIGHTING UNIT



- Lamp: LED, 120° angle, 6 500 K
- Luminosity: 400 lm
- Voltage/Frequency: 24-265 V DC/AC ~50/60 Hz
- Power consumption: 5 Watt
- Control of light: Built-in Motion Sensor, switch-off time 5 min.
- Mounting: Magnets
- Operating temperature range: -30°C – 70°C
- Dimensions: 357,4 × 32 × 35,5 mm (H × W × D)
- Weight: 140 gr.
- Certifications: CE, UL

Code	Description	Package
DP-OJ-06	Lighting unit 400 lm with motion sensor, for 24 to 265V/50-60Hz, magnetic fixing	1 set

EYE BOLTS



- Eye bolts for crane transport
- Application: for assembling with OMR-DN-xxxxxx-R, holes with internal threads under roof
- Material: zinc-plated carbon steel
- DIN580
- M10
- Package includes: 4 pcs

Code	Package
IDO-EB	1 set

RAMOS MONITORING SYSTEM

RAMOS PLUS



- 4 auto-sense intelligent sensor ports; can be set to either input or output
- All accessories powered via Intelligent ports
- Communication via SNMP v1, v2 and v3
- Notification via email and SNMP traps
- Fully embedded TCP/IP and web server
- Syslog and history with sensor graphs
- Network management system integration
- Security login for user and administrator
- Package includes: RAMOS Plus monitoring device, power adapter, 1.5 m crossover patch cord cable, bracket with screws and installation CD

➤ **RAMOS Plus** is an entry model of the RAMOS intelligent range, designed for use in indoor and outdoor cabinets. Available in either standard or GSM options, the latter with a built-in GSM modem and external antenna. Four intelligent ports provide ample opportunity for multiple use. Improved intelligent ports support a full range of accessories, including RAMOS Ultra for intelligent ports.

RAMOS PLUS	
Code	Package
RAMOS PLUS	1 set *
RAMOS PLUS GSM	1 set **

* RAMOS Plus monitoring device, power adapter, 1.5 m crossover patch cord cable, bracket with screws and installation CD.
 ** RAMOS Plus monitoring device with built-in 3G modem, GSM antenna with magnetic gripping and SMA connector, power adapter, 1.5 m crossover patch cord cable, bracket with screws and installation CD.

INTELLIGENT ACCESSORIES FOR RAMOS PLUS		
Code	Description	Package
RMS-I-ST	One wire temperature sensor with 30 cm cable; can be extended up to 30 m (Cat. 5/6 LAN) via Cat. 5 coupler (included)	1 set
RMS-I-STH	One wire temperature and humidity sensor with 30 cm cable. Humidity range 0–100%. Can be extended up to 30 m (Cat. 5/6 LAN) via CAT. 5 coupler (included).	1 set
RMS-I-STHB	One wire temperature and humidity sensor in Box with free 1.5 m LAN cable. Humidity range 0–100%. Can be extended up to 300 m (Cat. 5/6 LAN).	1 set
RMS-I-AF	Airflow sensor with attached 1.5 m LAN cable (Cat. 5). On/off airflow signal alarm.	1 set
RMS-I-AS	Siren & Strobe light with attached LAN cable (Cat. 5) 1.5 m. 100 db siren sound and flashing strobe interval 400x per minute. Cable can be extended up to 30 m (Cat. 5/6 LAN).	1 set
RMS-I-DE-01	Smoke detector with attached 1.5 m LAN cable (Cat. 5). On/off smoke detector alarm. Can be connected via dry contact when 9 V battery is used.	1 set
RMS-I-DE-02	PIR motion detector with attached 1.5 m LAN cable (Cat. 5). Can be connected in a chain of up to 10 Motion Detector Sensors on a single port. 60° detection angle. 3 m detection range.	1 set
RMS-I-DE-04	Spot water sensor with 4.5 m cable. Maximum cable extension 60 m.	1 set
RMS-I-DE-06	Rope water sensor with 3 m detection cable. 1.5 m LAN communication cable (Cat. 5) included (max. length 30 m). Protects water-sensitive equipment from potential disaster. Detects battery Acid for short-term exposure. Sensor cable can be extended via RMS-I-DE-06-EXT3.	1 set
RMS-I-DE-06-EXT3	3 m sensor rope extension for RMS-I-DE-06; maximum extension 50 m	1 set
RMS-I-DE-07	Rope water locate sensor with 3 m length detection cable, 6 m non-detection cable and connection cable 1.5 m; can be extended by LAN cable (Cat. 5e/6)	1 set
RMS-I-DE-07-EXT3	3 m rope sensor extension for RMS-I-DE-07; maximum extension 50 m	1 set
RMS-I-DRC	Dry contact with 4.5 m cable, input or output; sources up to 20 mA when used as input. Input voltage range 0 to 5 V.	1 set
RMS-I-MK	Magnetic door contact with 4.5 m cable (mounting holder included). Maximum extension 300 m. Open/closed contact switch.	1 set
RMS-I-PWR-NO	AC-Sensor controlled relay normally open (110 V / 220 V). 1.5 m LAN cable included; maximum length 30 m. Built-in 10A Fuse. C13 and C14 socket connection. Switch can be controlled by any sensor.	1 set
RMS-I-VC	4–20 mA Converter with attached 1.5 m LAN cable (Cat. 5). Collects analog values from a wide array of sensors.	1 set
RMS-I-CON	RJ45-RJ45 coupler (Cat. 5e) for sensor cable extension, package of 10 pcs	1 set
RAMOS ULTRA-EX-D8-8	Expansion board adds 8 dry contacts (IN/OUT) to one intelligent port (RJ45); each can be configured as input or output (sink up to 20 mA). Maximum length of connection cable (LAN Cat. 5/6) 300 m.	1 set
RMS-U-DST	Daisy-chain temperature sensor with attached 1.5 m LAN cable (Cat. 5). Up to 8 sensors can be connected to a single intelligent sensor port in 150 m total cable length.	1 set
RMS-U-DST-8	Package with 8 pcs of RMS-U-DST	1 package
RMS-U-RB-8	Box with 8 changeover relay contacts for control (manually or via notification)	1 set

RAMOS MINI



- Up to 3 temperature or humidity sensors (with new firmware)
- 1x dry contact input
- 1x output (relay switch contact up to 50 V DC)
- Two alert ranges per sensor
- Notification alarm via email and SNMP trap to several recipients
- Built-in graphic web interface for configuration and value monitoring
- Each sensor comes complete with unique ID
- Alarm updates via email and SNMP trap or SMS (over CONTEG Pro Server Software or 3rd-party software)
- Open communication protocols (web, email, SNMP, XML)
- Security: password
- Optional 255 data point graph view
- Package includes: RAMOS Mini, up to 3 sensors (temperature and humidity), 1x IN, 1x OUT, incl. RMS-ST-02, RMS-PW-05, straight and angle holder, installation CD

➤ **RAMOS Mini** is designed for deployment within a single rack, monitoring internal and external environments. Attached to a network, it reports the status of sensors deployed in and around racks to any location worldwide. Through the use of SNMP traps, it can fully integrate with any network management software.

RAMOS MINI	
Code	Package
RAMOS MINI	1 set

RAMOS MINI ACCESSORIES		
Code	Description	Package
RMS-ST-02	1-wire temperature sensor with 3 m cable; -10 °C to +80 °C	1 pc
RMS-SH-02	1-wire humidity sensor with 3 m cable; 0–100% RH	1 pc
RMS-ST-04	Daisy-chain temperature sensor with 3 m cable; -10 °C to +80 °C	1 pc
RMS-STH-02	Daisy-chain temperature and humidity sensor with 3 m cable; -10 °C to +80 °C; 0–100% RH	1 pc
RMS-DE-01	Optical smoke detector*	1 pc
RMS-DE-02	PIR motion detector*	1 pc
RMS-DE-04	Flood detector*	1 pc
RMS-DE-05	Broken glass dual detector*	1 pc
RMS-VS	Vibration sensor	1 pc
RMS-MK-01	Magnetic door contact with fixing bracket and 2.5 m cable	1 pc
RMS-CON-04	Hub for connecting two 1-wire sensors to 1 Wire bus	1 pc
RMS-AS-01	Acoustic siren with LED signaling, 120 dB*	1 pc
RMS-PWR-01	Power Box, remote switching external devices up to 230 V/10 A, power detection feature	1 pc
RMS-PW-05	Universal power supply 5 V DC	1 pc
RMS-PW-12	EU plug power supply for accessories 12 V DC	1 pc

* Requires external power supply 12V DC (e.g. RMS-PW-12).

Example of accessories for RAMOS Plus

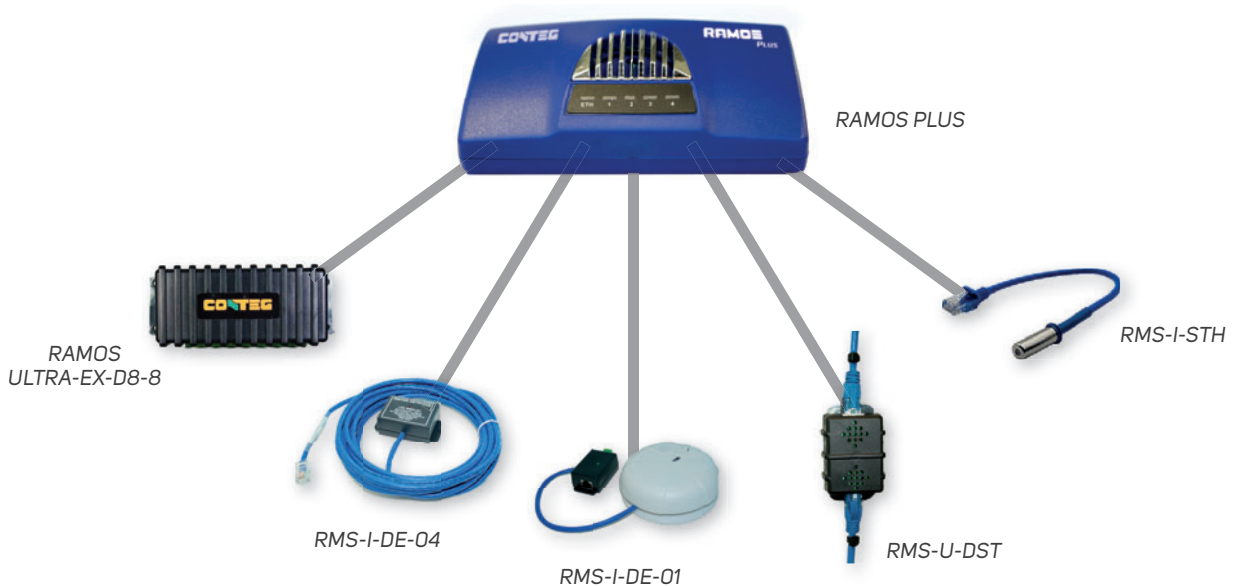

CLIMATE CONTROL SOLUTIONS FOR outTEG OMR

OUTDOOR COOLING UNITS

COMPACT—external mounting position



- Housing material: steel sheet, powder coated
- Color: RAL 7035 (light grey)
- Refrigerant: R134a
- Protection degree:
 - Cabinet air circuit: IP56
 - Ambient air circuit: IP24
- Option: additional heater, see page 43
- Mounting: External mounting
- Certification: CE, cURus, cULus
- Cut-outs for installation in CONTEG Modification Center
- Package includes: unit ready for connection

Note: Comes with outTEG outdoor cabinets, with a cut-out as specified on the side panel or door.



External mounting position

OUTDOOR AIR-CONDITIONING UNITS—WALL-MOUNTED, 550-1 000 W

Code *		AC-WMO-05-400C	AC-WMO-07-400C	AC-WMO-09-400C	AC-WMO-10-400C
Material		sheet steel	sheet steel	sheet steel	sheet steel
Dimensions (mm)	H	830	830	830	900
	W	304	304	304	304
	D	270	270	270	270
Minimum cabinet dimensions (doors or side)	H × W, H × D	1 000 × 500 mm	1 000 × 500 mm	1 000 × 500 mm	1 000 × 500 mm
Voltage/Frequency **		230 V; 50/60 Hz ~N	230 V; 50/60 Hz ~N	230 V; 50/60 Hz ~N	230 V; 50/60 Hz ~N
Cooling capacity to DIN 3168	L35 L35	550 W	750 W	850 W	1 000 W
	L35 L50	445 W	650 W	610 W	660 W
Rated power consumption	L35 L35	450 W	560 W	730 W	770 W
Max. air volume flow	Ambient air circuit	315 m³/h	315 m³/h	410 m³/h	320 m³/h
	Cabinet air circuit	165 m³/h	165 m³/h	200 m³/h	375 m³/h
Rated current	L35 L35	2,6 A	3,2 A	4,1 A	4 A
Starting current		10 A	11 A	16,5 A	16 A
Pre-Fuse T		5 A	6 A	10 A	10 A
Operating temperature range		-40 °C/+55 °C	-40 °C/+55 °C	-40 °C/+55 °C	-40 °C/+55 °C
Temperature range setting min/max		+20 °C/+50 °C	+20 °C/+50 °C	+20 °C/+50 °C	+20 °C/+50 °C
Weight		30 kg	30 kg	32 kg	38 kg
Compressor		reciprocating	reciprocating	reciprocating	reciprocating
Connection		connection terminals	connection terminals	connection terminals	connection terminals

* For stainless steel version use AC-WMO-xx-x2xx.

** Other input voltage upon request.

OUTDOOR AIR-CONDITIONING UNITS—WALL-MOUNTED, 1500-4 000 W						
Code *		AC-WMO-15-400C	AC-WMO-20-400C	AC-WMO-25-400C	AC-WMO-30-400C	AC-WMO-40-400C
Material		sheet steel	sheet steel	sheet steel	sheet steel	sheet steel
Dimensions (mm)	H	1150	1150	1550	1550	1550
	W	395	395	457	457	457
	D	270	270	355	355	355
Minimum cabinet dimensions (doors or side)	H × W, H × D	1200 × 600 mm	1200 × 600 mm	1600 × 800 mm	1600 × 800 mm	1600 × 800 mm
Voltage/Frequency **		230 V; 50/60 Hz ~N	230 V; 50/60 Hz ~N	230 V; 50/60 Hz ~N	230 V; 50/60 Hz ~N	230 V; 50/60 Hz ~N
Cooling capacity to DIN 3168	L35 L35	1500 W	2 000 W	2 500 W	3 000 W	4 000 W
	L35 L50	1220 W	1600 W	1970 W	2 380 W	3 180 W
Rated power consumption	L35 L35	800 W	1117 W	1030 W	1320 W	1880 W
Max. air volume flow	Ambient air circuit	655 m³/h	655 m³/h	765 m³/h	765 m³/h	990 m³/h
	Cabinet air circuit	400 m³/h	400 m³/h	950 m³/h	950 m³/h	950 m³/h
Rated current	L35 L35	4,6 A	5,5 A	4,4 A	5,8 A	8,9 A
Starting current		16 A	16 A	22,5 A	30 A	50 A
Pre-Fuse T		9 A	13 A	16 A	16 A	16 A
Operating temperature range		-40 °C/+55 °C	-40 °C/+55 °C	-40 °C/+55 °C	-40 °C/+55 °C	-40 °C/+55 °C
Temperature range setting min/max		+20 °C/+50 °C	+20 °C/50 °C	+20 °C/50 °C	+20 °C/50 °C	+20 °C/50 °C
Weight		48 kg	48 kg	78 kg	75,3 kg	82 kg
Compressor		reciprocating	rotary piston	rotary piston	rotary piston	rotary piston
Connection		connection terminals	connection terminals	connection terminals	connection terminals	connection terminals

* For stainless steel version use AC-WMO-xx-x2xx. ** Other input voltage upon request.

COOLING UNITS WITH ADDITIONAL HEATERS

For ordering of cooling unit with additional heater use code AC-WMO-xx-4xHx.

Code	Cooling capacity	Heating capacity	Temperature range	
			Cooling	Heating
AC-WMO-05-40HC	550	400	20 °C/50 °C	-20 °C/+20 °C
AC-WMO-07-40HC	750	400	20 °C/50 °C	-20 °C/+20 °C
AC-WMO-09-40HC	850	400	20 °C/50 °C	-20 °C/+20 °C
AC-WMO-10-40HC	1000	400	20 °C/50 °C	-20 °C/+20 °C
AC-WMO-15-40HC	1500	1000	20 °C/50 °C	-20 °C/+20 °C
AC-WMO-20-40HC	2 000	1000	20 °C/50 °C	-20 °C/+20 °C
AC-WMO-25-40HC	2 500	1500	20 °C/50 °C	-20 °C/+20 °C
AC-WMO-30-40HC	3 000	1500	20 °C/50 °C	-20 °C/+20 °C
AC-WMO-40-40HC	4 000	2 000	20 °C/50 °C	-20 °C/+20 °C

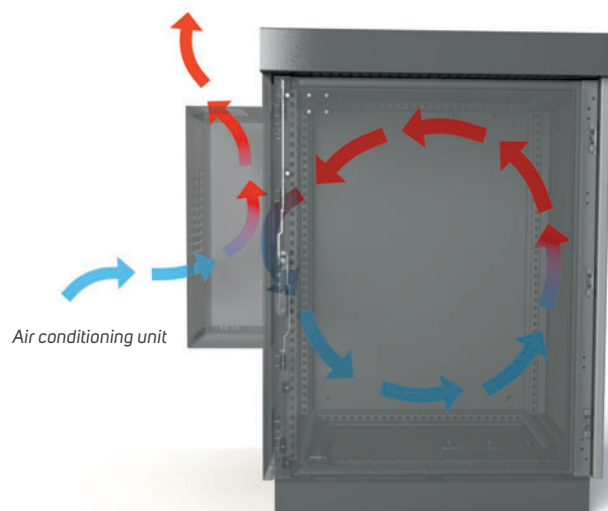

COOLING AND HEATING

THERMOELECTRIC COOLERS

THERMOELECTRIC COOLERS, COOLING POWER 100–800 W						
Code		ID-EP-10X-1	ID-EP-10X-4	ID-EP-20X-4	ID-EP-40X-4	ID-EP-80X-4
Dimensions (mm)	H	200	280	500	600	972
	W	304	350	330	432	514
	D	138 (74 mm outside of cabinet)	165 (113 mm outside of cabinet)	196 (130 mm outside of cabinet)	202 (135 mm outside of cabinet)	211 (135,5 mm outside of cabinet)
Cut out dimension		160 × 260 mm	252 × 322 mm	472 × 302 mm	550 × 382 mm	922 × 464 mm
Cooling capacity to DIN 3168"		100 W	100 W	200 W	400 W	800 W
Max. air volume flow	Ambient air circuit	128 m³/h	128 m³/h	106 m³/h	240 m³/h	480 m³/h
	Cabinet air circuit	46 m³/h	46 m³/h	150 m³/h	240 m³/h	480 m³/h
Voltage/Frequency		24 V DC	120–230 V AC – 50/60Hz	120–230 V AC – 50/60Hz	120–230 V AC – 50/60Hz	120–230 V AC – 50/60Hz
Starting current		4,8 A	1,6 A (120V) 0,8 A (230V)	2,9 A (120V) 1,5 A (230V)	5,8 A (120V) 3 A (230V)	11,6 A (120V) 6 A (230V)
Max. current		7,4 A	1,1 A (120V) 0,6 A (230V)	2 A (120V) 1 A (230V)	4 A (120V) 2,1 A (230V)	8 A (120V) 4,2 A (230V)
Fuse		8 A (T)	2 A (T) (120V) 1 A (T) (230V)	3 A (T) (120V) 2 A (T) (230V)	6 A (T) (120V) 4 A (T) (230V)	12 A (T) (120V) 7 A (T) (230V)
Connection		connection terminal block	8-pole connector	8-pole connector	8-pole connector	8-pole connector
Operating temp. range		–20 °C / +65 °C	–20 °C / +65 °C	–20 °C / +65 °C	–20 °C / +65 °C	–20 °C / +65 °C
Weight		5,9 kg	9,4 kg	17,2 kg	34 kg	66 kg
Power supply		ID-PS-120-41	integrated	integrated	integrated	integrated



ID-EP-10X-1

- Material: stainless steel housing
- Protection degree: IP66
- Sealing: permanent sealing gasket in closed cell foam polyethylene
- Connection by terminal block
- Regulation: for more information, please contact our technical support
- Package includes: thermoelectric cooling unit ready for connection



ID-PS-120-41

POWER SUPPLIES FOR THERMOELECTRIC UNITS		
Code	ID-PS-120-41	
Dimensions (mm)	H	125
	W	60
	D	113
Power		120 W
Input voltage		110–240 V AC; 90–350 V DC
Output voltage		24 V DC
Current		5 A
Weight		0,62 kg
Mounting position		DIN rail
Rated temperature range		–40 °C / +70 °C



Outdoor cabinet outTEG OMR with thermoelectric coolers

HEATERS



- Material: aluminum profile
- Technology: PTC, self regulating
- ID-EH-80F-4: two heating circuits
- Ingress protection: IP20
- Installation: snap-on fixing on DIN rail 35 mm EN 50022
- Package includes: heater ready for connection

HEATERS		
Code	ID-EH-25PF-4	ID-EH-80F-4
Thermal output (W)	250	450/800
Number of heating circuits	1	2
Operation voltage (V AC)	230	230
Operating temperature range (°C)	-10 °C/+50 °C	-40 °C/+60 °C
Dimension (mm)	H	193
	W	61,5
	D	85
Fan	Airflow (m ³ /h)	-
	Operation voltage (VAC)	230
Weight (kg)	0,7	0,8
Electrical connection	3 poles terminal	6 poles terminal

THERMOSTAT FOR COOLING AND HEATING



- Sensor element: thermostatic bi-metal
- Maximum tolerance: ± 4 K
- Switching difference (hysteresis) is $7^{\circ}\text{C} \pm 3$ K
- Switching capacity (max. load):
 - 15 A resistive/ 2 A inductive @ 120 V AC
 - 10 A resistive/ 2 A inductive @ 120 V AC
 - DC 30 W
 - Connections: 2-pole terminal for AWG 14 max. (2,5 mm²)
- Mounting: clip for 35 mm DIN rail
- Dimensions (H x W x D): 55 x 33 x 43 mm
- Setting temperature range: 0 to + 60 °C
- Operating temperature: -20 to + 80 °C
- Weight: 40 g
- Thermostat for cooling—contact normally open
- Thermostat for heating—contact normally closed
- Package includes: thermostat ready for connection

Code	Package
Thermostat for cooling (NO)	
ID-EO-TC	1 pc
Thermostat for heating (NC)	
ID-EO-TH	1 pc

HYGROSTAT



- Installation: DIN rail 35 mm
- Connection: screw terminals
- Range of humidity control: 35–100 % RH
- Switching capacity (max. load): 5 A/230 V
- Switching hysteresis: ± 3 % RH
- Dimensions (H x W x D): 67 x 50 x 38 mm
- Package includes: hygrometer ready for connection

Code	Package
ID-EO-HY	1 pc

Circuit diagram of heater controlled with thermostat or hygrometer.

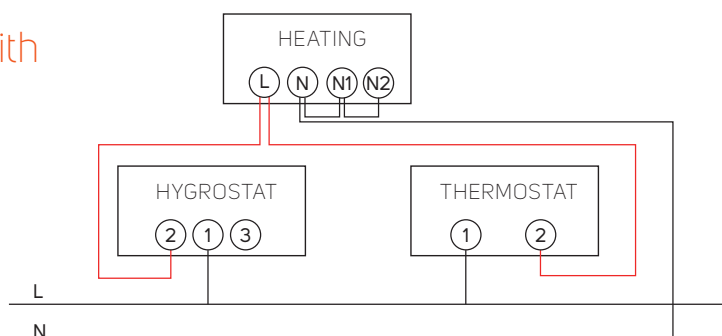

DRAINAGE DEVICE



- Material: plastic according to UL94 V-0, umbra grey, waterproof with UV protection
- Protection degree: IP67
- Sealing: NBR
- Dimensions: Ø 60×49,5 mm, 17,5 mm inside cabinet
- Water flow rate: 200 ml/hour
- Mounting: vertically at the lowest point, thread M50×1.5 with nut (cut-out Ø 50 mm)
- Package includes: 1 pc of drainage device

Code	Package
ID-EO-DD	1 pc

PRESSURE COMPENSATOR



- Mounting: PG 29 thread with union nut (cut-out diameter 37 mm)
- Fitting position: vertical (Protection type is restricted to IP54 if fitting position of pressure compensator is not vertical.)
- Material: plastic according to UL94 V-0, light grey RAL 7035
- Protection degree: IP55
- Dimensions: Ø 65,5 × 30,5 mm
- Package includes: 2pcs of compensator

Code	Package
ID-EO-PC	2 ks

VENTILATION UNITS—DP-VEN



- One to nine fans
- Possible to install: in 19" extrusions—horizontally
- Temperature range -10 °C to 55 °C
- Thermostat ranging from 0 °C to 60 °C included; no thermostat option
- Voltage range 230V/50Hz (48V DC option)
- Protection category to EN 60 529 IP20
- Color: RAL (standard RAL 9005)
- Package includes: ventilation unit ready for connection

Code	Outlet grid	Airflow (m³/h)	Rated current max. (A)	Power consumption (W)	Annual power consumption* (kWh/year)	Possible heat removal** (kW)	Package
DP-VEN-03 *	ID-EF-07	336	0,270	57	499	0,57	1 pc
DP-VEN-06 **	ID-EF-09	672	0,540	114	999	1,14	1 pc

* You have to order 2 pcs of ID-EF-07.

** You have to order 2 pcs of ID-EF-09.

OUTLET FILTER GRID



- Material: PC/ABS Alloy, PA 66 GH13 HSL for elastic clips
- Color: RAL 7035
- Protection degree: IP54/IP55
- Package includes: unit ready for mounting.

Code	For filter fan units	Package
ID-EF-07	250 × 250 mm, airflow max. 270 m³/h	1 pc
ID-EF-09	325 × 325 mm, airflow max. 800 m³/h	1 pc

TECHNICAL DRAWINGS

outTEG OMR—free-standing outdoor cabinets—double-walled

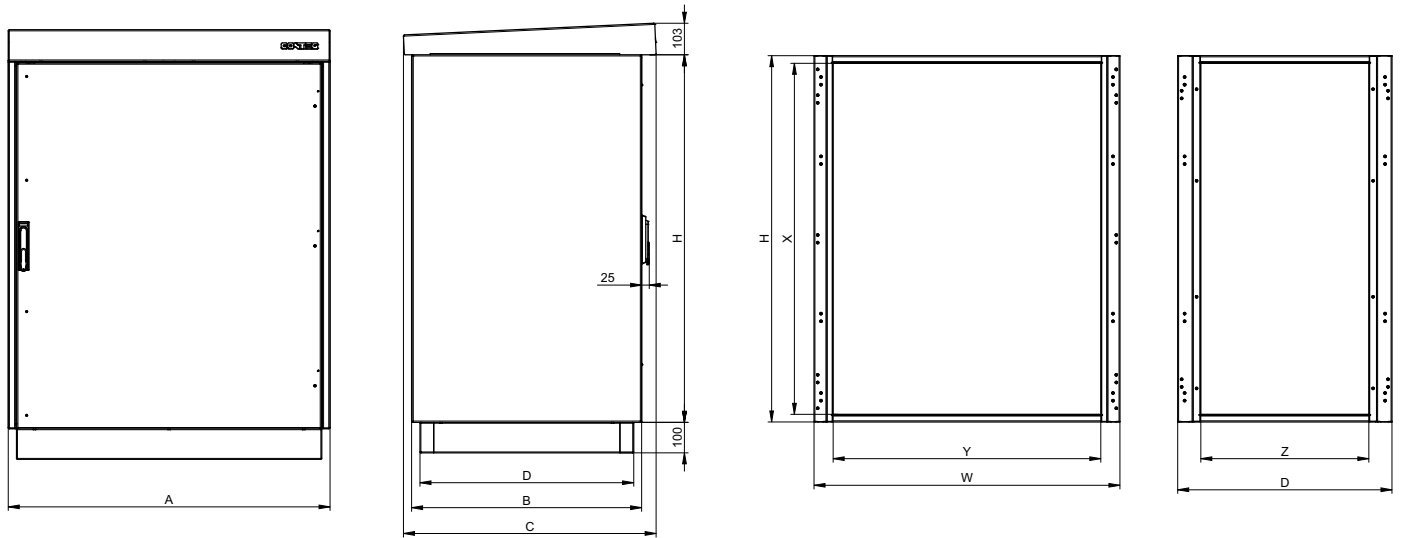

Code	Height (mm)		Width (mm)			Depth (mm)			
	H	X	W	A	Y	D	B	Z	C
OMR-DN-066506-R	600	550	652	704	527	602	654	450	728
OMR-DN-086506-R	800	750	652	704	527	602	654	450	728
OMR-DN-106506-R	1000	950	652	704	527	602	654	450	728
OMR-DN-100805-R	1000	950	802	854	677	502	554	350	628
OMR-DN-120808-R	1200	1150	802	854	677	802	854	650	928
OMR-DN-121007-R	1200	1150	1002	1054	877	702	754	550	828
OMR-DN-146506-R	1400	1350	652	704	527	602	654	450	728
OMR-DN-166504-R	1600	1550	652	704	527	402	454	250	528
OMR-DN-160807-R	1600	1550	802	854	677	702	754	550	828
OMR-DN-160810-R	1600	1550	802	854	677	1002	1054	850	1128
OMR-DN-161008-R	1600	1550	1002	1054	877	802	854	650	928

HEAT LOSS DISPERSION

outTEG OMR—free-standing outdoor cabinet, double-walled,
measuring inside cabinet, $\Delta T = 15 \text{ K}$, wind speed 0 m/s

Code	H (mm)	W (mm)	D (mm)	Thickness of material (mm)	Surface (m ²)	Effective area *	Heating dissipation (W)
OMR-DN-066506-R	600	650	600	2,00	2,28	1,60	64,08
OMR-DN-086506-R	800	650	600	2,00	2,78	2,06	82,57
OMR-DN-106506-R	1000	650	600	2,00	3,28	2,52	101,05
OMR-DN-100805-R	1000	800	500	2,00	3,40	2,62	105,17
OMR-DN-120808-R	1200	800	800	2,00	5,12	4,01	161,22
OMR-DN-121007-R	1200	1000	700	2,00	5,48	4,30	172,67
OMR-DN-146506-R	1400	650	600	2,00	4,28	3,44	138,01
OMR-DN-166504-R	1600	650	400	2,00	3,88	3,16	126,76
OMR-DN-160807-R	1600	800	700	2,00	5,92	4,83	193,96
OMR-DN-160810-R	1600	800	1000	2,00	7,36	5,98	240,37
OMR-DN-161008-R	1600	1000	800	2,00	7,36	5,98	240,37

* Cabinet standing alone, area without bottom.

Do you need a customized solution?

Use services of our **CONTEG Modification Center**.



➤ Individual orders are fulfilled in the **modification center, which is a part of a modern industrial enterprise in Pelhrimov**. The center also has a MODCentrum 29 CNC milling machine. We can cut holes for filter fans, coolers, control panels, and buttons. The cabinets can be made of sheet steel, stainless steel (AISI 304 and 316L) or aluminum.

Cutouts can be made on flat removable parts of the rack walls (doors, cable entries, side panels, roofs and mounting plates), as well as in welded monolithic cabinets.



For more information please contact our sales or technical team at www.conteg.com/contacts

The image features two black outdoor cabinets, one mounted on a pole to the left and one on a pole to the right. The cabinets are rectangular with a textured top section containing ventilation slats and the brand name 'outTEG'. The background is a vibrant blue with a blurred, motion-streaked effect. The text is centered over the image in white.

outTEG OMR LITE
POLE OR
WALL MOUNTED
OUTDOOR CABINETS



Main advantages and description	32
Accessories	34
Climate control solution—cooling and heating	40
Technical drawings	43
Heat loss dispersion	43

outTEG OMR LITE—POLE OR WALL MOUNTED OUTDOOR CABINETS



OMR-DL-080605

➤ The **outTEG OMR LITE outdoor cabinets** presents an ideal solution for projects with high demands on safety of installed equipment and on stable in-rack climate with the possibility of installation on a pole or a wall. Double-walled case design safeguards the installed components from all-weather as well as from vandalism thanks to the cabinet's compact structure which prevents access to the installed components from the outside. For extreme weather conditions, the side panel variants can be modified to allow the installation of fans or air-conditioning units. Resistance to weather is ensured mainly by the AlMg3 alloy used for the cabinet case and the applied finish of polyester powder coating with UV protection.

MAIN ADVANTAGES

- Compact and light double-walled design
- Highest protection against corrosion
- Features integrated roof
- Made of aluminum alloy AlMg3
- Polyester powder coating with UV protection
- PUR non-porous gasket—suitable for extreme temperatures

COLOR:  RAL 7035

DESCRIPTION

- | | | | |
|--|--|---|--|
| <p>Material</p> <ul style="list-style-type: none"> • Aluminum alloy AlMg3 <p>Coating</p> <ul style="list-style-type: none"> • Polyester powder coating with UV protection <p>Color</p> <ul style="list-style-type: none"> • RAL 7035 for outdoor use • Optionally RAL 7046 for roof | <p>IP Rating</p> <ul style="list-style-type: none"> • IP65 according to EN60529 (degree of protection can be reduced after mounting some accessories) <p>Mechanical protection</p> <ul style="list-style-type: none"> • IK10 according to IEC 6226 | <p>Supply includes</p> <ul style="list-style-type: none"> • Double-walled outdoor cabinet, fully mounted and assembled with perforated roof • Natural ventilation between inner and outer walls • Front door with two handles, key combination 333, door stop. Easily | <ul style="list-style-type: none"> configured to a right or left hand door mounting • Perforated internal horizontal rails on side panels • Door stop |
|--|--|---|--|

outTEG OMR LITE							
Outdoor cabinet	H (mm)	500	600	600	800	800	
	H (U)	–	12	12	17	17	
	W (mm)	400	600	600	600	600	
	D (mm)	400	500	600	500	600	
Material thickness (mm)	Body	2	2	2	2	2	
	Roof	2	2	2	2	2	
	Door	2	2	2	2	2	
Weight (kg)		22,5	34	36,5	43,5	46,5	
Code		OMR-DL-050404	OMR-DL-060605	OMR-DL-060606	OMR-DL-080605	OMR-DL-080606	
ACCESSORIES							
Mounting plate		1 pc	ID-W-SP5040	ID-W-SP6060	ID-W-SP6060	ID-W-SP8060	ID-W-SP8060
19" extrusions		1 pair	–	ID-W-U12	ID-W-U12	ID-W-U17	ID-W-U17
Vertical rails		1 pair	ID-W-H5	ID-W-H6	ID-W-H6	ID-W-H8	ID-W-H8
Plinth 100 mm	Front and rear parts	1 set	ID-F-SPF04	ID-F-SPF06	–	–	–
	Side parts	1 set	ID-F-SPS04	ID-F-SPS05	–	–	–
Brackets for pole mounting		1 set*	ID-W-MP4	ID-W-MP6	ID-W-MP6	ID-W-MP6	ID-W-MP6
Brackets for wall mounting		1 set*	ID-W-WB	ID-W-WB	ID-W-WB	ID-W-WB	ID-W-WB

* For right installation we recommend to use 2 sets.



OMR-DL-080605



OMR-DL-080605



OMR-DL-080605 + ID-W-MP6 on a pole

outTEG OMR LITE—POLE OR WALL MOUNTED OUTDOOR CABINETS

ACCESSORIES

POLE-MOUNTING BRACKETS



- Material: 2 mm stainless steel
- Installation: for poles with diameter up to 250 mm
- Load: 200 kg
- Package includes: pole-mounting brackets and all necessary assembly parts (2 profile rails, 2 clamping straps (l=850 mm), 8 sets: screws M8×12, self-locking nuts and washers adhesion)

Code	For cabinet width (mm)
ID-W-MP4	400
ID-W-MP6	600

WALL-MOUNTING BRACKETS



- Material: 3 mm stainless steel
- Load: 100 kg
- Package includes: wall-mounting brackets and all necessary assembly parts for mounting to the cabinet

Code	Package
ID-W-WB	4 pcs

PLINTH



- Height: 100 mm
- Material: 2 mm stainless steel 1.4016 (AISI 403)
- Surface finish: polyester-powder coat
- Color: RAL 7046
- You must order ID-x-SPSxx and ID-x-SPFxx
- Package includes: plinths and all necessary assembly parts

PLINTH outTEG OMR LITE—SIDE KIT		
Code	For cabinet depth (mm)	Package *
ID-F-SPS04	400	1 set
ID-F-SPS05	500	1 set

* 1 set includes: 2× side part, mounting accessories.

PLINTH outTEG OMR LITE—FRONT AND REAR KIT		
Code	For cabinet width (mm)	Package *
ID-F-SPF04	400	1 set
ID-F-SPF06	600	1 set

* 1 set includes: 1× front part, 1× rear part, mounting accessories.

DOOR SWITCH



- Material—brackets: 2 mm zinc-plated sheet steel
- Door switch: IP65, plastic, 1NO + 1 NC, PG13,5, -25 °C to +70 °C
- Usage: available for outdoor cabinets of minimum height 500 mm and depth 250 mm
- Package includes: door switch and all necessary assembly parts

Code	Package
ID-W-DC	1 pc

POCKET FOR DOCUMENTS



- Material: ABS
- Color: RAL7035
- Dimensions: 234 × 241 × 31 mm (H × W × D)
- Mounting: with self-adhesive tape
- Package includes: plastic pocket for documents and adhesive tape

Code	Package
ID-PO-A4	1 pc

LIGHTING UNIT



- Lamp: LED, 120° angle, 6 500 K
- Luminosity: 400 lm
- Voltage/Frequency: 24-265 V DC/AC ~50/60 Hz
- Power consumption: 5 Watt
- Control of light: Built-in Motion Sensor, switch-off time 5 min.
- Mounting: Magnets
- Operating temperature range: -30°C – 70°C
- Dimensions: 357,4 × 32 × 35,5 mm (H × W × D)
- Weight: 140 gr.
- Certifications: CE, UL

Code	Description	Package
DP-OJ-06	Lighting unit 400 lm with motion sensor, for 24 to 265V/50-60Hz, magnetic fixing	1 set

EARTHING



- ID-W-EK: complete earthing kit for cabinet
- ID-W-EW68/EW88/EW8816: 300 mm cable length with crimped lugs
- Set includes: nuts, screws for earthing door(s), cabinet and mounting plate

Code	Description	Package
ID-W-EK	Complete earthing kit inTEG WME	1 set
ID-W-EW68	Grounding wires M6, M8 (door, cabinet), cross-section 10 mm ²	10 pcs
ID-W-EW88	Grounding wires M8, M8 (cabinet, mounting plate), cross-section 10 mm ²	10 pcs
ID-W-EW8816	Grounding wires M8, M8 (cabinet, mounting plate), cross-section 16 mm ²	10 pcs

RAILS FOR INTERIOR INSTALLATION

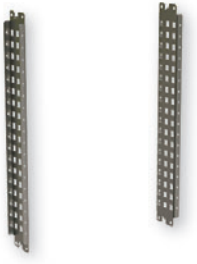

- Material: 2 mm zinc-plated sheet steel with 25 mm perforation
- Rail width: 75 mm
- Installation: on interior horizontal rails which are part of cabinet
- Usage: available for outdoor cabinets of minimum depth 250 mm
- Package includes: 2 rails for internal installation and all necessary assembly parts

Code	For cabinet height (mm)	Package *
ID-W-H5	500	1 set
ID-W-H6	600	1 set
ID-W-H8	800	1 set

* 1 set—2 pcs.

19" FIXED EXTRUSIONS



- Material: 2 mm zinc-plated sheet steel
- Rail width: 56 mm
- Installation: on interior rails which are part of cabinet or on ID-W-UB brackets for 800 mm wide outdoor cabinets
- Usage: available for cabinets of minimum depth 250 mm and width 600 and 800 mm
- Package includes: 19" fixed extrusions and all necessary assembly parts

Code	For cabinet height (mm)	Package *
ID-W-U12	600 (12U)	1 set
ID-W-U17	800 (17U)	1 set

* 1 set—2 pcs.

MOUNTING PLATE



- Material: zinc-plated sheet steel
- Package includes: Mounting plate with labeled 50 × 50 mm raster (assembly parts are included in cabinet accessories)

Code	For cabinet height × width (mm)	Material thickness (mm)	Package
ID-W-SP5040	500 × 400	2,5	1 pc
ID-W-SP6060	600 × 600	2,5	1 pc
ID-W-SP8060	800 × 600	3 F *	1 pc

* 3 F—3mm mounting plate with 2 bent edges.

outTEG OMR LITE—natural ventilation

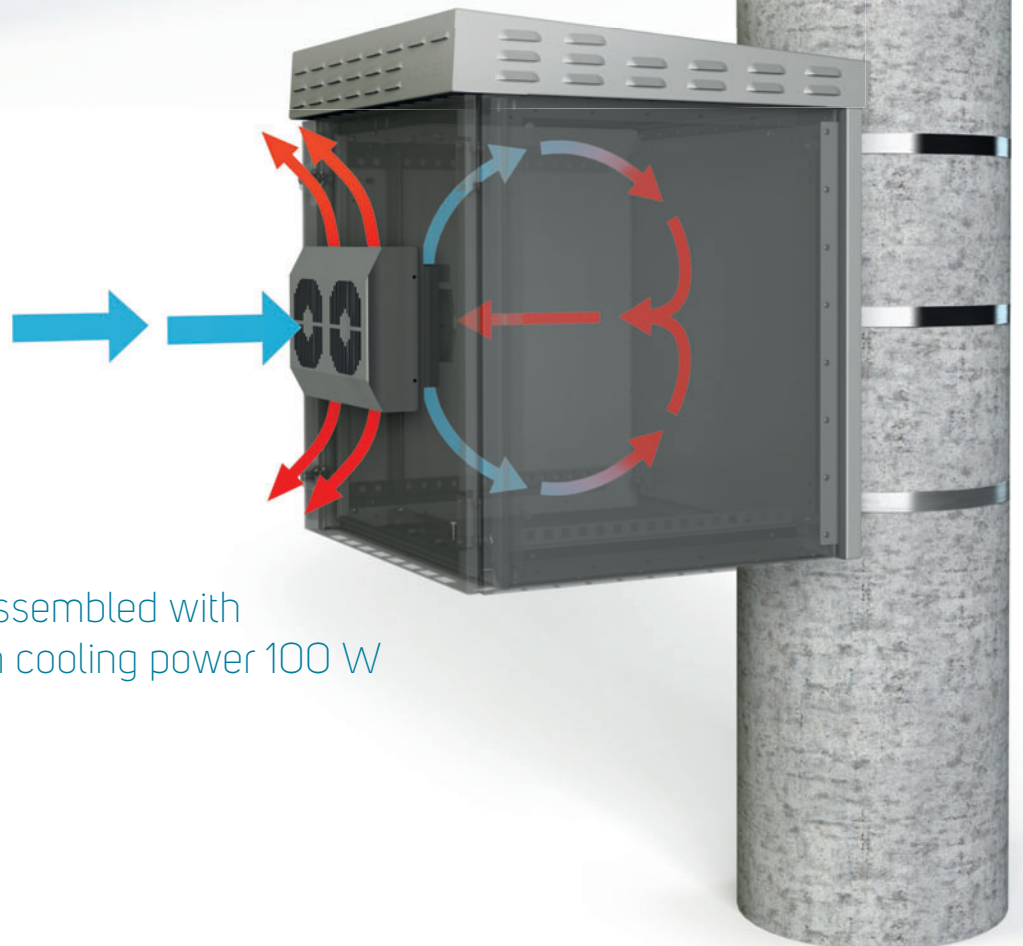
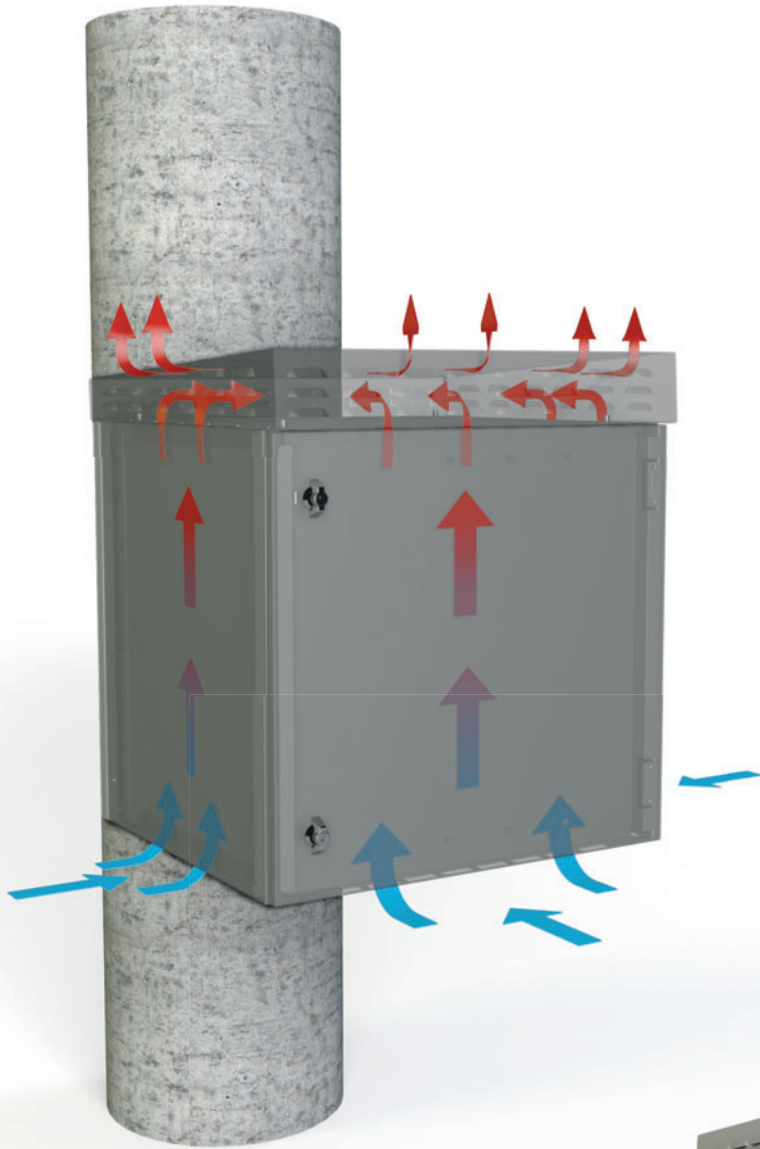

outTEG OMR LITE— assembled with thermoelectric unit with cooling power 100 W

CABLE GLANDS AND NUTS WITH PG/METRIC THREAD



- Material: polyamide PA6, sealing CR (neoprene)
- Protection degree: IP68
- Color: RAL 7035

Code	Description	Thread size	Ø cable (mm)	Package
ORO-PG7N	Cable entry Pg7	Pg7	2,5 – 6,5	10 pcs
ORO-PG9N	Cable entry Pg9	Pg9	3 – 8	5 pcs
ORO-PG11N	Cable entry Pg11	Pg11	4 – 10	5 pcs
ORO-PG13N	Cable entry Pg13	Pg13	5,5 – 12	5 pcs
ORO-PG16N	Cable entry Pg16	Pg16	8,5 – 14	5 pcs
ORO-PG21N	Cable entry Pg21	Pg21	11 – 18	5 pcs
ORO-PG29N	Cable entry Pg29	Pg29	17 – 25	5 pcs
ORO-PG36N	Cable entry Pg36	Pg36	22 – 33	1 pc
ORO-PG42N	Cable entry Pg42	Pg42	28 – 38	1 pc
ORO-PG48N	Cable entry Pg48	Pg48	32 – 44	1 pc
ORO-ZPG7N	Plastic nut Pg7	Pg7	–	10 pcs
ORO-ZPG9N	Plastic nut Pg9	Pg9	–	5 pcs
ORO-ZPG11N	Plastic nut Pg11	Pg11	–	5 pcs
ORO-ZPG13N	Plastic nut Pg13	Pg13	–	5 pcs
ORO-ZPG16N	Plastic nut Pg16	Pg16	–	5 pcs
ORO-ZPG21N	Plastic nut Pg21	Pg21	–	5 pcs
ORO-ZPG29N	Plastic nut Pg29	Pg29	–	5 pcs
ORO-ZPG36N	Plastic nut Pg36	Pg36	–	1 pc
ORO-ZPG42N	Plastic nut Pg42	Pg42	–	1 pc
ORO-ZPG48N	Plastic nut Pg48	Pg48	–	1 pc
ORO-M12N	Cable entry M12×1,5	M12×1,5	2,5 – 6,5	10 pcs
ORO-M16N	Cable entry M16×1,5	M16×1,5	4,5 – 10	5 pcs
ORO-M20N	Cable entry M20×1,5	M20×1,5	7 – 13	5 pcs
ORO-M25N	Cable entry M25×1,5	M25×1,5	10 – 17	5 pcs
ORO-M32N	Cable entry M32×1,5	M32×1,5	17 – 25	5 pcs
ORO-ZM12N	Plastic nut M12×1,5	M12×1,5	–	10 pcs
ORO-ZM16N	Plastic nut M16×1,5	M16×1,5	–	5 pcs
ORO-ZM20N	Plastic nut M20×1,5	M20×1,5	–	5 pcs
ORO-ZM25N	Plastic nut M25×1,5	M25×1,5	–	5 pcs
ORO-ZM32N	Plastic nut M32×1,5	M32×1,5	–	5 pcs

MEMBRANE ENTRY



- Material: polyamid/elastomer, UL-94 Vo, self-extinguishing
- Protection: IP64
- Installation: cut-outs into cable glands
- Cut-outs for installation in CONTEG Modification Center
- Package includes: membrane 1 pc

Code	Dimensions W x D (mm)	Cables	Package
ID-W-ME24/19	142 × 44	12× max Ø 6,5 mm; 7× Ø 2,1 mm	1 pc
ID-W-ME24/48	142 × 44	48× max Ø 6,5 mm	1 pc

Do you need a customized solution?

Use services of our **CONTEG Modification Center**.



➤ Individual orders are fulfilled in the **modification center, which is a part of a modern industrial enterprise in Pelhrimov**. The center also has a MODCentrum 29 CNC milling machine. We can cut holes for filter fans, coolers, control panels, and buttons. The cabinets can be made of sheet steel, stainless steel (AISI 304 and 316L) or aluminum.

Cutouts can be made on flat removable parts of the rack walls (doors, cable entries, side panels, roofs and mounting plates), as well as in welded monolithic cabinets.



For more information please contact our sales or technical team at www.conteg.com/contacts

CLIMATE CONTROL SOLUTIONS FOR outTEG OMR LITE

COOLING AND HEATING

THERMOELECTRIC COOLERS



ID-EP-10X-1

- Material: stainless steel housing
- Protection degree: IP66
- Sealing: permanent sealing gasket in closed cell foam polyethylene
- Connection by terminal block
- Regulation: for more information, please contact our technical support
- Package includes: thermoelectric cooling unit ready for connection

THERMOELECTRIC COOLERS, COOLING POWER 100–800 W			
Code		ID-EP-10X-1	ID-EP-10X-4
Dimensions (mm)	H	200	280
	W	304	350
	D	138 (74 mm outside of cabinet)	165 (113 mm outside of cabinet)
Cut out dimension		160 × 260 mm	252 × 322 mm
Cooling capacity to DIN 3168"		100 W	100 W
Max. air volume flow	Ambient air circuit	128 m ³ /h	128 m ³ /h
	Cabinet air circuit	46 m ³ /h	46 m ³ /h
Voltage/Frequency		24V DC	120–230V AC – 50/60Hz
Starting current		4,8 A	1,6A (120V) 0,8A (230V)
Max. current		7,4 A	1,1A (120V) 0,6A (230V)
Fuse		8 A (T)	2 A (T) (120V) 1 A (T) (230V)
Connection		connection terminal block	8-pole connector
Operating temperature range		–20 °C / +65 °C	–20 °C / +65 °C
Weight		5,9 kg	9,4 kg
Power supply		ID-PS-120-41	integrated



ID-PS-120-41

POWER SUPPLIES FOR THERMOELECTRIC UNITS		
Code		ID-PS-120-41
Dimensions (mm)	H	125
	W	60
	D	113
Power		120 W
Input voltage		110–240 V AC, 90–350 V DC
Output voltage		24 V DC
Current		5 A
Weight		0,62 kg
Mounting position		DIN rail
Rated temperature range		–40 °C/+70 °C

HEATERS



- Material: aluminum profile
- Technology: PTC, self regulating
- ID-EH-80F-4: two heating circuits
- Ingress protection: IP20
- Installation: snap-on fixing on DIN rail 35 mm EN 50022
- Package includes: heater ready for connection

HEATERS		
Code	ID-EH-25PF-4	ID-EH-80F-4
Thermal output (W)	250	450/800
Number of heating circuits	1	2
Operation voltage (VAC)	230	230
Operating temperature range (°C)	-10 °C/+50 °C	-40 °C/+60 °C
Dimension (mm)	H	193
	W	61,5
	D	85
Fan	Airflow (m ³ /h)	-
	Operation voltage (VAC)	230
Weight (kg)	0,7	0,8
Electrical connection	3 poles terminal	6 poles terminal

THERMOSTAT FOR COOLING AND HEATING



- Sensor element: thermostatic bi-metal
- Maximum tolerance: ± 4 K
- Switching difference (hysteresis) is $7^\circ\text{C} \pm 3$ K
- Switching capacity (max. load):
 - 15 A resistive/ 2 A inductive @ 120 V AC
 - 10 A resistive/ 2 A inductive @ 120 V AC
 - DC 30 W
 - Connections: 2-pole terminal for AWG 14 max. (2,5 mm²)
- Mounting: clip for 35 mm DIN rail
- Dimensions (H x W x D): 55 x 33 x 43 mm
- Setting temperature range: 0 to + 60 °C
- Operating temperature: -20 to + 80 °C
- Weight: 40 g
- Thermostat for cooling—contact normally open
- Thermostat for heating—contact normally closed
- Package includes: thermostat ready for connection

Code	Package
Thermostat for cooling (NO)	
ID-EO-TC	1 pc
Thermostat for heating (NC)	
ID-EO-TH	1 pc

HYGROSTAT



- Installation: DIN rail 35 mm
- Connection: screw terminals
- Range of humidity control: 35–100 % RH
- Switching capacity (max. load): 5 A/230 V
- Switching hysteresis: ± 3 % RH
- Dimensions (H x W x D): 67 x 50 x 38 mm
- Package includes: hygrometer ready for connection

Code	Package
ID-EO-HY	1 pc

Circuit diagram of heater controlled with thermostat or hygrometer.

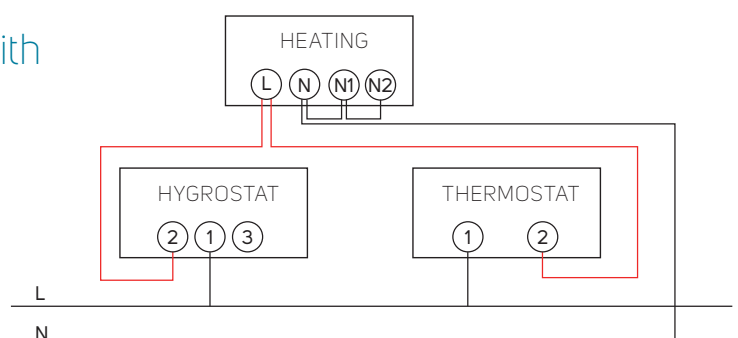

DRAINAGE DEVICE



- Material: plastic according to UL94 V-0, umbra grey, waterproof with UV protection
- Protection degree: IP67
- Sealing: NBR
- Dimensions: Ø 60×49,5 mm, 17,5 mm inside cabinet
- Water flow rate: 200 ml/hour
- Mounting: vertically at the lowest point, thread M50×1.5 with nut (cut-out Ø 50 mm)
- Package includes: 1 pc of drainage device

Code	Package
ID-EO-DD	1 pc

PRESSURE COMPENSATOR



- Mounting: PG 29 thread with union nut (cut-out diameter 37 mm)
- Fitting position: vertical (Protection type is restricted to IP54 if fitting position of pressure compensator is not vertical.)
- Material: plastic according to UL94 V-0, light grey RAL 7035
- Protection degree: IP55
- Dimensions: Ø 65,5 × 30,5 mm
- Package includes: 2pcs of compensator

Code	Package
ID-EO-PC	2 ks

TECHNICAL DRAWINGS

outTEG OMR LITE—outdoor cabinets —pole or wall mount, double-walled

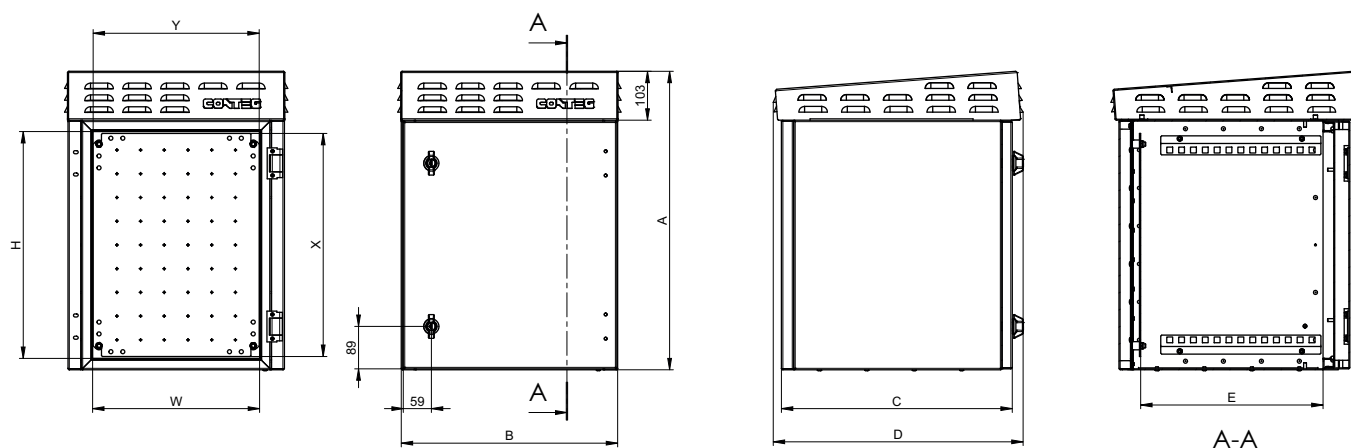

Code	Height (mm)		Width (mm)		Depth (mm)			Mounting plate (mm)	
	A	H	B	W	C	D	E	X	Y
OMR-DL-050404	630	478	456	352	487	527	384,5	470	350
OMR-DL-060605	730	578	656	556	587	627	484,5	570	550
OMR-DL-060606	730	578	656	556	687	727	584,5	570	550
OMR-DL-080605	930	778	656	556	587	627	484,5	770	550
OMR-DL-080606	930	778	656	556	687	727	584,5	770	550

HEATING DISSIPATION

outTEG OMR LITE—outdoor cabinets—pole or wall mount, double-walled, measuring inside cabinet, $\Delta T = 15$ K, wind speed 0 m/s

Code	H (mm)	W (mm)	D (mm)	Thickness of material (mm)	Surface (m ²)	Effective area—without single-walled bottom (m ²)	Heating dissipation (W)
OMR-DL-050404	500	400	400	2	1,12	0,88	35,16
OMR-DL-060605	600	600	500	2	1,92	1,60	64,08
OMR-DL-060606	600	600	600	2	2,16	1,82	72,92
OMR-DL-080605	800	600	500	2	2,36	2,00	80,16
OMR-DL-080606	800	600	600	2	2,64	2,26	90,60



FSM-0—
FREE-STANDING
COMPACT
STAINLESS STEEL
CABINETS



Main advantages and description	46
Accessories	49
Climate control solution—filter fans	57
Climate control solution—cooling units	58
Climate control solution—cooling units airflow	60
Technical drawings	61
Heat loss dispersion	62

FSM-O—FREE-STANDING COMPACT STAINLESS STEEL OUTDOOR CABINETS



FSM-O-201004

➤ **FSM-O free-standing compact outdoor cabinets** are made of stainless steel. FSM-O cabinets have integrated side panels in the frame and a surface finish resistant to UV radiation, which protects against harmful environmental influences. The compact welded construction of the cabinet is made of profiled side panels joined together by crossbar profiles. This manufacturing method can meet the highest requirements for rigidity and lends the cabinet 700 kg of load-bearing capacity. Thanks to the design of the bottom frame, FSM-O can be used even without an extra plinth. To create a variety of mounting surfaces and planes, we offer a wide range of system accessories designed for optimal use of the frame profile. We also supply components to control the environment inside the cabinet, such as heating units, filtered fans or active cooling units.

MAIN ADVANTAGES

- Welded compact construction with integrated side panels—stainless steel with polyester powder coating surface finish with UV protection
- Load capacity 700 kg
- Single-door cabinet designs
- Can be installed without an additional supporting plinth
- Designer lift-up handle—the standard for all cabinet types
- Easy to close doors thanks to a special locking system
- Maximum use of interior space—possibility of placing the mounting plate between the rear posts
- Side panels integrated in the frame
- 17 sizes from 1 400 × 600 × 300 mm up to 2 000 × 1 000 × 400 mm
- Wide assortment of accessories
- Wide assortment of tailor-made customer solutions—cut-outs according to your requirements before and after final surface finishing accessories



FSM-O-201004



Wide range of system rails creates additional mounting levels for individual installation.

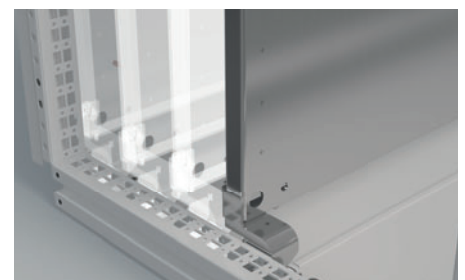

Maximum use of interior space—possibility of placing the mounting plate between the rear uprights.

COLOR:  RAL 7035

FSM-O—FREE-STANDING COMPACT STAINLESS STEEL CABINETS

OUTDOOR VERSION

DESCRIPTION

Material

- Cabinet: stainless steel
- Mounting plate: zinc-plated sheet steel

Cabinet surface finish

- Polyester powder coating with UV protection

Color

- RAL 7035 for outdoor use

Degree of protection

- IP55 according to the EN 60529 norm (the degree of protection can be reduced after mounting some accessories)

Mechanical durability

- IK10 according to IEC 62262

Supply includes

- Welded construction with integrated side panels
- Full single-door with swing handle is equipped with a four-point locking system

- The door hinges are located on the right-hand side of the single-door cabinet (option to switch the door mounting from right to left is available)
- Rear and top panel
- Gland plate
- Mounting plate with raster

FSM-O—FREE-STANDING COMPACT OUTDOOR STAINLESS STEEL CABINETS , HEIGHT 1400 AND 1600 mm								
Cabinet	H (mm)	1400	1400	1600	1600	1600	1600	1600
	W (mm)	600	600	600	800	800	1000	1000
	D (mm)	300	400	400	300	400	300	400
Mounting plate	H1 (mm)	1291	1291	1491	1491	1491	1491	1491
	W2 (mm)	497	497	497	697	697	897	897
Material thickness (mm)	Rear and top panel	1.25/1.5						
	Door	2	2	2	2	2	2	2
	Mounting plate	3	3	3	3	3	3	3
Door		1	1	1	1	1	1	1
Gland plate, number of parts		2	2	2	2	2	2	2
Weight (kg)		75	81	82	104	109	120	132
Code	1 pc	FSM-O-140603	FSM-O-140604	FSM-O-160604	FSM-O-160803	FSM-O-160804	FSM-O-161003	FSM-O-161004
ACCESSORIES								
Plinth 100 mm	front and rear	1 set	ID-F-SPF06	ID-F-SPF06	ID-F-SPF06	ID-F-SPF08	ID-F-SPF08	ID-F-SPF10
	side parts		ID-F-SPS03	ID-F-SPS04	ID-F-SPS04	ID-F-SPS03	ID-F-SPS04	ID-SPS03

To order the cabinet without the mounting plate, use order number FSM-O-xxxxxx-01.

FSM-O—FREE-STANDING COMPACT OUTDOOR STAINLESS STEEL CABINETS , HEIGHT 1800 mm								
Cabinet	H (mm)	1800	1800	1800	1800	1800	1800	1800
	W (mm)	600	800	800	800	1000	1000	1000
	D (mm)	400	300	300	400	400	400	400
Mounting plate	H1 (mm)	1691	1691	1691	1691	1691	1691	1691
	W2 (mm)	497	697	697	697	897	897	897
Material thickness (mm)	Rear and top panel	1.25/1.5						
	Door	2	2	2	2	2	2	2
	Mounting plate	3	3	3	3	3	3	3
Door		1	1	1	1	1	1	1
Gland plate, number of parts		2	2	2	2	2	2	2
Weight (kg)		99	104	104	109	109	146	146
Code	1 pc	FSM-O-180604	FSM-O-180803	FSM-O-180804	FSM-O-180804	FSM-O-181004	FSM-O-181004	FSM-O-181004
ACCESSORIES								
Plinth 100 mm	front and rear	1 set	ID-F-SPF06	ID-F-SPF08	ID-F-SPF08	ID-F-SPF08	ID-F-SPF10	ID-F-SPF10
	side parts		ID-F-SPS04	ID-F-SPS03	ID-F-SPS03	ID-F-SPS04	ID-F-SPS04	ID-F-SPS04

To order the cabinet without the mounting plate, use order number FSM-O-xxxxxx-01.

FSM-O—FREE-STANDING COMPACT OUTDOOR STAINLESS STEEL CABINETS, HEIGHT 2 000 mm								
Cabinet	H (mm)		2 000	2 000	2 000	2 000	2 000	
	W (mm)		600	600	800	800	1 000	
	D (mm)		300	400	300	400	500	400
Mounting plate	H1 (mm)		1 891	1 891	1 891	1 891	1 891	
	W2 (mm)		497	497	697	697	897	
Material thickness (mm)	Rear and top panel		1.25/1.5					
	Door		2	2	2	2	2	
	Mounting plate		3	3	3	3	3	
Door			1	1	1	1	1	
Gland plate, number of parts			2	2	2	2	2	
Weight (kg)			102	107	124	132	159	
Code	1 pc		FSM-O-200603	FSM-O-200604	FSM-O-200803	FSM-O-200804	FSM-O-200805	FSM-O-201004
ACCESSORIES								
Plinth 100 mm	front and rear	1 set	ID-F-SPF06	ID-F-SPF06	ID-F-SPF08	ID-F-SPF08	ID-F-SPF08	ID-F-SPF10
	side parts		ID-F-SPS03	ID-F-SPS04	ID-F-SPS03	ID-F-SPS04	ID-F-SPS05	ID-F-SPS04

To order the cabinet without the mounting plate, use order number FSM-O-xxxxxx-01.

Recommended Accessories



Cooling units



Filter fans



Horizontal and vertical extrusions

FSM-O—FREE-STANDING COMPACT STAINLESS STEEL CABINETS

ACCESSORIES

PLINTHS



- Material: 2mm stainless steel
- Color: RAL 9005
- It is necessary to order front and side set together
- Possibility of installing two plinths of 100 mm height apart
- Supply includes: mounting accessories

Code for 100 mm high plinth	For cabinet width (mm)	Package
Plinth—front and rear set		
ID-F-SPF06	600	1 set
ID-F-SPF08	800	1 set
ID-F-SPF10	1000	1 set

Code for 100 mm high plinth	For cabinet depth (mm)	Package
Plinth—sides set		
ID-F-SPS03	300	1 set
ID-F-SPS04	400	1 set
ID-F-SPS05	500	1 set

SEALING SET IP55

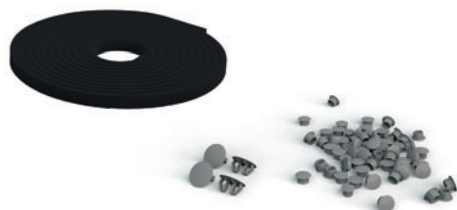

- Material: PVC
- Application: plugs and sealing tape for IP55 protection
- Supply includes: whole set for FSM cabinet

Code	Package
ID-F-KIT55	1 pc

SPARE MOUNTING PLATE

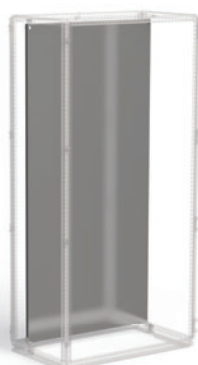

- Material: 3mm zinc-plated sheet steel
- Supply includes: mounting plate with marked raster, mounting accessories and brackets

Code	For cabinet height × width (mm)
ID-F-SP1806	1800 × 600
ID-F-SP1808	1800 × 800
ID-F-SP1810	1800 × 1000
ID-F-SP2006	2000 × 600
ID-F-SP2008	2000 × 800
ID-F-SP2010	2000 × 1000

LOWER BRACKETS FOR MOUNTING PLATES



- Material: 5 mm zinc-plated sheet steel
- Application: to allow the mounting plate to be moved out of the rear position of the frame
- Mounting: mount on the lower side of the frame profile
- Supply includes: mounting accessories

Code	Package
ID-F-SBR	1 set

SIDE BRACKETS FOR MOUNTING PLATES



- Material: 2mm zinc-plated sheet
- Application: for additional mounting plate fixation and vibration reduction
- Mounting: mount on horizontal ID-F-Hxx or ID-F-NHxx rails or directly on the upright
- Supply includes: mounting accessories

Code	Package
ID-F-LBP	1 set

HORIZONTAL/VERTICAL EXTRUSIONS



ID-F-H (for mounting on the sides of the frame profiles)



ID-F-NH (for mounting between the frame profiles)

- Material: 2mm zinc-plated sheet steel
- Rail width: 90 mm (ID-F-H), 41.2 mm (ID-F-NH)
- Application: to create more mounting planes (horizontal and vertical)
- Mounting: ID-F-Hx on the sides of the frame profiles
- Mounting: ID-F-NHx between the frame profiles
- Supply includes: mounting accessories

Code	For cabinets high/width/depth (mm)	Load capacity in horizontal position	Load capacity in vertical position	Package *
Mounting on the sides of the frame profiles				
ID-F-H4	400	140 kg	240 kg	1 set
ID-F-H5	500	100 kg	240 kg	1 set
ID-F-H6	600	70 kg	240 kg	1 set
ID-F-H8	800	50 kg	180 kg	1 set
ID-F-H10	1000	50 kg	140 kg	1 set
ID-F-H12	1200	50 kg	120 kg	1 set
ID-F-H18	1800	36 kg	80 kg	1 set
ID-F-H20	2000	32 kg	70 kg	1 set
Mounting between the frame profiles				
ID-F-NH4	400	95 kg	95 kg	1 set
ID-F-NH5	500	85 kg	85 kg	1 set
ID-F-NH6	600	70 kg	70 kg	1 set
ID-F-NH8	800	56 kg	56 kg	1 set
ID-F-NH10	1000	45 kg	45 kg	1 set
ID-F-NH12	1200	35 kg	35 kg	1 set
ID-F-NH18	1800	21 kg	21 kg	1 set
ID-F-NH20	2000	20 kg	20 kg	1 set

* 1 set—2 pcs.

HORIZONTAL EXTRUSIONS

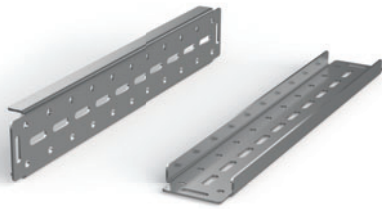

- Material: 3mm zinc-plated sheet steel
- Rail width: 87.5 mm
- Application: for installing high weight components
- Mounting: mount on frame profiles
- Supply includes: mounting accessories

Code	For cabinets width/depth (mm)	Load capacity in horizontal position	Package *
ID-F-HH4	400	260 kg	1 set
ID-F-HH5	500	210 kg	1 set
ID-F-HH6	600	175 kg	1 set
ID-F-HH8	800	130 kg	1 set
ID-F-HH10	1 000	100 kg	1 set

* 1 set—2 pcs.

DOOR-MOUNTING RAILS



- Material: 2mm zinc-plated sheet steel
- Rail width: 20 mm
- Application: for creating more mounting planes on the inner sides of the doors
- Mounting: into the door frame
- Supply includes: mounting accessories

Code	For door/wing dimensions (mm)	Package *
ID-F-VD6	600	1 set
ID-F-VD8	800	1 set
ID-F-VD10	1 000	1 set

* 1 set—2 pcs.

PROFILE FOR CABLE FIXING

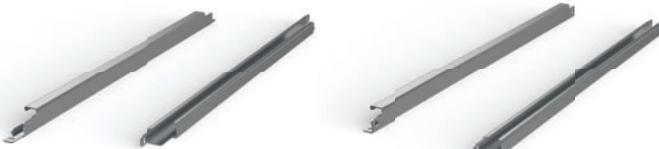

- Material: 2mm zinc-plated sheet steel
- Application: for cable glands
- Mounting: mount on the lower side profile of the frame or on the mounting plate (ID-F-RCUxx)
- Mounting: mount between the bottom side frame profiles (ID-F-RCxx)
- Supply includes: mounting accessories

Code	Code	For cabinets width/depth (mm)	Package *
ID-F-RC4	ID-F-RCU4	400	1 set
ID-F-RC6	ID-F-RCU6	600	1 set
ID-F-RC8	ID-F-RCU8	800	1 set
ID-F-RC10	ID-F-RCU10	1 000	1 set

* 1 set—2 pcs.

EYE BOLTS



- Eye bolts for crane transport
- Application: for assembling with FSM, holes with internal threads under roof
- Material: zinc-plated carbon steel
- DIN580
- M12
- Package includes: 4 pcs

Code	Package
ID-F-EB	1 set

Possibilities to install horizontal and vertical rails

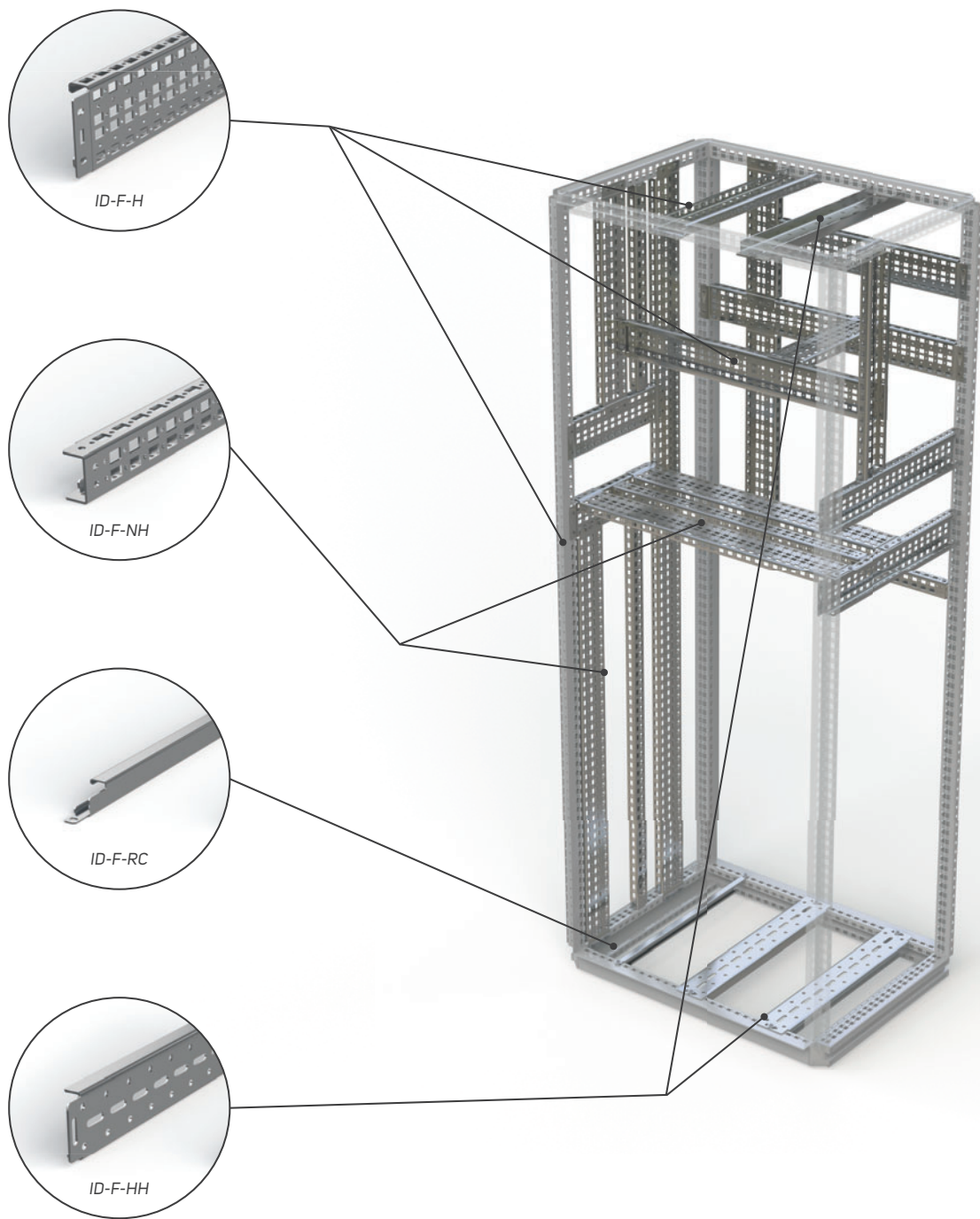

19" RAILS



- Material: 2mm zinc-plated sheet steel
- Application: to make 19" planes in the FSM cabinets
- Mounting: onto the ID-F-UBxx + ID-F-Hxx brackets
- Supply includes: 19" vertical extrusions and mounting accessories

Code *	For cabinet height × width (mm)	Package
ID-F-V186	1 800 × 600 (36U)	1 set
ID-F-V206	2 000 × 600 (42U)	1 set
ID-F-V188	1 800 × 800 (36U)	1 set
ID-F-V208	2 000 × 800 (42U)	1 set

* It's necessary to order 19" brackets ID-F-UBxx.

19" BRACKETS



ID-F-UB08

ID-F-UB06

- Material: 1.5mm (ID-F-UB06); 2mm (ID-F-UB08) zinc-plated sheet steel
- Application: to make 19" planes in the FSM cabinets of width 600 and 800 mm
- Mounting: onto system extrusions ID-F-Hxx
- Supply includes: brackets for 19" vertical extrusions and mounting accessories

Code	For cabinet width (mm)	Package *
ID-F-UB06	600	1 set
ID-F-UB08	800	1 set

* 1 set—6 pcs.

Mounting 19" extrusion

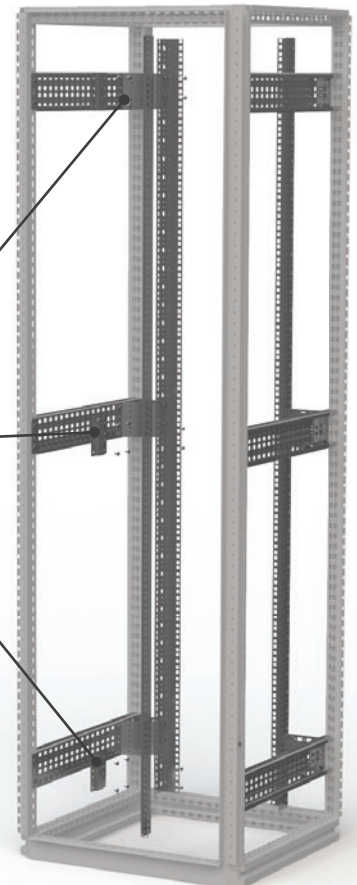
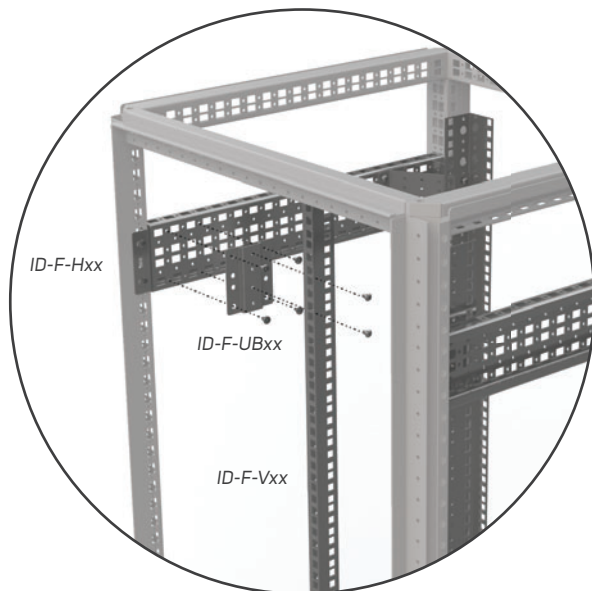

19" SWING FRAME

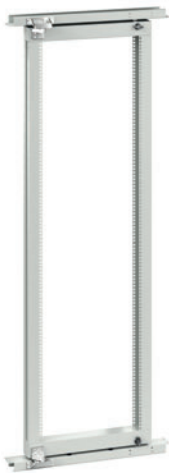

- Material: 2mm sheet steel
- Swing frame load-bearing capacity: 150 kg
- Use: to create a swinging 19" plane and an access point to the back of the rack cabinet with width of 800 mm
- Installation: onto the cabinet structure
- Supply includes: 19" swing frame including a lock and horizontal crossbars for mounting

Code	For cabinet height × width (mm)	Package
ID-F-1808-SF15	1800 × 800	1 set
ID-F-2008-SF15	2 000 × 800	1 set

DOOR STOP



- Application: for FSM cabinets
- Supply includes: door stop and mounting accessories

Code	Package
ID-F-DS	1 pc

DOOR SWITCH



- Brackets material: 2mm zinc-plated sheet steel
- Door switch: IP65, plastic, 1NO + 1NC, PG13.5, -25 °C to +70 °C
- Supply includes: door switch and mounting accessories

Code	Package
ID-F-DC	1 pc

UTILITY LECTERN



- Material: 1.5mm sheet steel
- Color: RAL 7035
- Mounting: mount onto the door frame
- Dimensions: depth 356 mm, width—suitable for the specific cabinet dimensions
- Supply includes: mounting accessories

Code	For cabinet width (mm)	Package
ID-F-CDD6	600	1 set
ID-F-CDD8	800	1 set
ID-F-CDD10	1000	1 set

PARTIAL MOUNTING PLATE



- Material: 3mm zinc-plated sheet steel
- Application: to create additional front and side mounting planes, the plates are versatile and can be mounted horizontally to the appropriate cabinet width or vertically to the appropriate cabinet depth
- Mounting: mount horizontally or vertically on the frame profiles or system rails
- Supply includes: mounting accessories

Code	For cabinet width (mm)	For cabinet depth (mm)	Mounting plane height (mm)
ID-F-PMP0604	600	–	400
ID-F-PMP0604	–	400	600
ID-F-PMP0605	600	–	500
ID-F-PMP0605	–	500	600
ID-F-PMP0804	800	–	400
ID-F-PMP0804	–	400	800
ID-F-PMP0806	800	–	600
ID-F-PMP0806	–	600	800
ID-F-PMP1004	1000	–	400
ID-F-PMP1004	–	400	1000
ID-F-PMP1204	1200	–	400
ID-F-PMP1204	–	400	1200

LOCKS/LOCK INSERTS



- Application: spare inserts instead of the standard 5 mm double-bar
- Supply includes: mounting accessories

Code	Type	Package
ID-F-INLK1	Lock for inTEG FSE/FSM, key 5333	1 set
ID-F-INLK3	Lock for inTEG FSE/FSM, unique key	1 set
ID-F-INS7	Lock insert 7 mm SQUARE, black zamak	1 set
ID-F-INS8	Lock insert 8 mm SQUARE, black zamak	1 set
ID-F-INT7	Lock insert 7 mm TRIANGULAR, black zamak	1 set
ID-F-INT8	Lock insert 8 mm TRIANGULAR, black zamak	1 set
ID-F-INLKE1	Lockable VW 1 cap	1 set
ID-F-INSS	Complete handle	1 set
ID-F-INSSA	Door plate double-bar 5 mm	1 set

EARTHING



- Material: tinned copper
- Supply includes: various lengths and cross-sections of flat conductors with pressed contact holes with an M8 opening

Code	Type	Package
ID-F-EK1	Flat earthing conductor for M8, length 200 mm, cross-section 16 mm ²	10 pcs
ID-F-EK2	Flat earthing conductor for M8, length 200 mm, cross-section 25 mm ²	10 pcs
ID-F-EK3	Flat earthing conductor for M8, length 300 mm, cross-section 16 mm ²	10 pcs
ID-F-EK4	Flat earthing conductor for M8, length 300 mm, cross-section 25 mm ²	10 pcs

FASTENERS



- Supply includes: M6x16 ISO 7380 Zn (ID-W-SMS6x16) cage nuts, screws, hinge, pull-out brackets and fasteners for FSM (ID-F-CK)

Code	Description	Package
ID-W-CNM6	Cage nut M6	10 pcs
ID-W-SMS6x16	Screw M6x16, ISO 7380, Zn	10 pcs
ID-W-CNM8	Cage nut M8	10 pcs
ID-W-SMS8x16	Screw M8x16, ISO 7380, Zn	10 pcs
ID-F-CK	Hinge, pull-out brackets, replacement fasteners for FSM	1 set

FLUORESCENT LAMPS WITH A DOOR SWITCH AND SOCKET

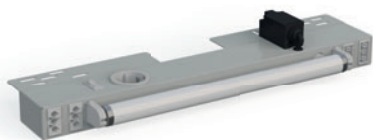

- Material: powder coated sheet steel
- Application: to light up the interior of the cabinet, option of connecting several light fixtures
- Mounting: mount on FSM frames
- Degree of protection: IP20
- Supply includes: complete lighting unit with door switch and Schuko/UTE socket, potential-free contact for control of switchboard temperature control elements, connection connector

Code	Typ	Package
ID-F-L14SKR-SCH	For FSE/FSM cabinet W 600 mm, 14W, 230 V AC, 50 Hz, socket Schuko	1 pc
ID-F-L18SKR-SCH	For FSE/FSM cabinet W 800 mm, 18W, 230 V AC, 50 Hz, socket Schuko	1 pc
ID-F-L14SKR-CZ	For FSE/FSM cabinet W 600 mm, 14W, 230 V AC, 50 Hz, socket UTE	1 pc
ID-F-L18SKR-CZ	For FSE/FSM cabinet W 800 mm, 18W, 230 V AC, 50 Hz, socket UTE	1 pc
ID-F-LN30	Power supply cord orange, length 3m, 3x1.5mm ²	1 pc
ID-F-LL30	Power supply cord orange, length 3m, 3x0.75mm ²	1 pc
ID-F-LAC166STG	Connector for the inter-connection cable gray	1 pc
ID-F-LAB-14	Plastic cover for lamps 14W	1 pc
ID-F-LAB-18	Plastic cover for lamps 18W	1 pc
ID-F-LV-06	Inter-connection cable, length 0.6 m	1 pc
ID-F-LV-12	Inter-connection cable, length 1.0 m	1 pc

LED LIGHT



- Material: PC, transparent and ABS
- Application: to light up the interior of the cabinet, option of connecting several light fixtures
- Mounting: mount onto the frame profiles or by magnets
- Dimensions: 357.4 × 32 × 31.16 mm
- Degree of protection: IP20
- Supply includes: complete lighting unit with rocker switch, inter-connection cables

Code	Type	Package
ID-F-L	Lighting unit LED 4 W, 24-265 V (DC/AC), 0/50/60 Hz	1 pc

POCKETS FOR DOCUMENTS



- Material: ABS
- Color: RAL 7035
- Dimensions: 234 × 241 × 31 mm (H × W × D)
- Mounting: with a self-adhesive tape
- Supply includes: pocket for documents and self-adhesive tape



- Material: 1mm sheet steel
- Color: RAL 7035
- Mounting: onto the door frame
- Supply includes: pocket for documents and mounting accessories

Code	Package
ID-PO-A4	1 pc

Code	For door/wing dimensions (mm)	Package
ID-F-MP06	600	1 set
ID-F-MP08	800	1 set
ID-F-MP10	1000	1 set

CLIMATE CONTROL SOLUTIONS FOR FSM-O

FILTER FANS



MAIN ADVANTAGES

- Quick assembly without screws and tools into a square cut-out, easy to mount with highly elastic clips
- Easy filter insert replacement from the outside without tools
- Possible to change airflow direction
- Airflow up to 800 m³/h
- Can be mounted in a cabinet with a sheet thickness of 1-2.5 mm
- IP 54 standard degree of protection
- Side and top ventilator placement
- Operating temperature range -10 °C up to +70 °C
- Polyurethane foam sealing around the whole perimeter
- Resistance against UV radiation
- Holes for installation in the CONTEG Modification Center

DESCRIPTION

- Plastic parts made of ABS/PC mix, all parts are self-extinguishing according to UL 94V-0
- Standard color RAL 7035 (different color on request)
- Filter inserts made of synthetic fibres of class G3 according to EN

- 779 and class G4 according to EN 779 and UL 900 class 2 self-extinguishing in class F1 according to DIN 53 438
- Filter inserts are cleaned by washing, compressed air and banging

- Encapsulated fan ball bearings
- IP54 standard degree of protection EN 60529 and NEMA 12 according to UL 50
- IP55 settable (according to EN 60529)

- IP56 when using protective cover against splashing water
- EMC version available on request

Fans

Code	Airflow	Dimensions H × W × D	Voltage **	Frequency	Outlet filter grid	Cut-out dimensions	Degree of protection
ID-EF-01-4	12/15 m ³ /h	106.5 × 106.5 × 59.9 mm	230 VAC	50/60 Hz	ID-EF-01	92 × 92 mm	IP54
ID-EF-01-1	15 m ³ /h	106.5 × 106.5 × 59.9 mm	24 VDC	–	ID-EF-01	92 × 92 mm	IP54
ID-EF-04-4	45/50 m ³ /h	150 × 150 × 65.5 mm	230 VAC	50/60 Hz	ID-EF-03	125 × 125 mm	IP54
ID-EF-04-1	47 m ³ /h	150 × 150 × 65.5 mm	24 VDC	–	ID-EF-03	125 × 125 mm	IP54
ID-EF-10-4	100/110 m ³ /h	203.9 × 203.9 × 87.5 mm	230 VAC	50/60 Hz	ID-EF-05	177 × 177 mm	IP54
ID-EF-10-1	100 m ³ /h	203.9 × 203.9 × 87.5 mm	24 VDC	–	ID-EF-05	177 × 177 mm	IP54
ID-EF-23-4	230/270 m ³ /h	250 × 250 × 115.3 mm	230 VAC	50/60 Hz	ID-EF-07	223 × 223 mm	IP54
ID-EF-22-1	225 m ³ /h	250 × 250 × 115.3 mm	24 VDC	–	ID-EF-07	223 × 223 mm	IP54
ID-EF-52-4	520/580 m ³ /h	325 × 325 × 150.7 mm	230 VAC	50/60 Hz	ID-EF-09	291 × 291 mm	IP54
ID-EF-71-4	710/800 m ³ /h	325 × 325 × 149 mm	230 VAC	50/60 Hz	ID-EF-09	291 × 291 mm	IP54
ID-EFT-42-4 *	420/490 m ³ /h	324 × 324 × 94 mm	230 VAC	50/60 Hz	ID-EF-09	fan 175 × 175 mm/grid 291 × 291 mm	IP54
ID-EO-TC	Thermostat for cooling	55 × 33 × 43 mm	250 VAC/10 A	–	–	–	IP20

* Top version.

** Other input voltage options available upon request.



For more detailed information, please refer to the product catalog "Climate control solutions" at www.conteg.com or contact our sales representatives.

CLIMATE CONTROL SOLUTIONS FOR FSM-O

COOLING UNITS



MAIN ADVANTAGES

- Cooling capacity from 320 W up to 4 000 W
- Easy maintenance—units don't require filter inserts
- Higher cooling capacity and reliability thanks to highly efficient condenser made of aluminum
- Units are environmentally friendly—cooling medium R134a
- Robust stainless steel cases
- Simple regulation and monitoring
- Easy and fast mounting (side and top version)
- High-quality components ensure long service life and reliability (such as the Mitsubishi Electric rotary piston compressor)
- Transport units in any position
- World-recognized certifications (CE, cURus, cULus)
- Holes for installation in the CONTEG Modification Center

DESCRIPTION

Material

- Sheet steel/stainless steel

Cooling medium

- R134a

Degree of protection

- Outer circle IP54
- Inner circle IP24

Mounting type

- External
- Fully recessed

Certification

- CE, cURus, cULus

Supply includes:

- Unit prepared for connection and immediate use

Cooling units SLIM (wall-mounted or fully recessed mounting)

Code	Cooling capacity	Dimensions H × W × D	Voltage *	Frequency	Version	Cut-out dimensions	Degree of protection
AC-WM3-03-4200	320 W	520 × 270 × 110 mm	230 VAC	50/60 Hz	Stainless steel	501 × 251 mm	IP54/IP24
AC-WM3-04-4200	400 W	520 × 320 × 110 mm	230 VAC	50/60 Hz	Stainless steel	504 × 308 mm	IP54/IP24
AC-WM3-05-4200	500 W	600 × 320 × 110 mm	230 VAC	50/60 Hz	Stainless steel	581 × 301 mm	IP54/IP24
AC-WM3-08-4200	820 W	980 × 395 × 145 mm	230 VAC	50/60 Hz	Stainless steel	954 × 376 mm	IP54/IP24
AC-WM3-08-6200	820 W	980 × 395 × 145 mm	400 VAC	50/60 Hz	Stainless steel	954 × 376 mm	IP54/IP24
AC-WM3-11-4200	1100 W	1250 × 395 × 145 mm	230 VAC	50/60 Hz	Stainless steel	1214 × 376 mm	IP54/IP24
AC-WM3-11-6200	1100 W	1250 × 395 × 145 mm	400 VAC	50/60 Hz	Stainless steel	1214 × 376 mm	IP54/IP24
AC-WM3-15-4200	1500 W	1550 × 395 × 145 mm	230 VAC	50/60 Hz	Stainless steel	1531 × 376 mm	IP54/IP24
AC-WM3-15-6200	1500 W	1550 × 395 × 145 mm	400 VAC	50/60 Hz	Stainless steel	1531 × 376 mm	IP54/IP24

* Other input voltage options available upon request.

Cooling units COMPACT (wall-mounted)

Code	Cooling capacity	Dimensions H × W × D	Voltage *	Frequency	Material	Cut-out dimensions	Degree of protection
AC-WM4-03-4200	320/360 W	500 × 280 × 200 mm	230 VAC	50/60 Hz	Stainless steel	480 × 240 mm	IP54/IP24
AC-WM4-05-4200	550/620 W	650 × 315 × 260 mm	230 VAC	50/60 Hz	Stainless steel	635 × 275 mm	IP54/IP24
AC-WM4-05-6200	550/620 W	650 × 315 × 260 mm	400 VAC	50/60 Hz	Stainless steel	635 × 275 mm	IP54/IP24
AC-WM4-08-4200	750/780 W	650 × 315 × 260 mm	230 VAC	50/60 Hz	Stainless steel	635 × 275 mm	IP54/IP24
AC-WM4-08-6200	750 W	650 × 315 × 260 mm	400 VAC	50/60 Hz	Stainless steel	635 × 275 mm	IP54/IP24
AC-WM4-10-4200	1000/1080 W	650 × 315 × 260 mm	230 VAC	50/60 Hz	Stainless steel	635 × 275 mm	IP54/IP24
AC-WM4-10-6200	1 000 W	650 × 315 × 260 mm	400 VAC	50/60 Hz	Stainless steel	635 × 275 mm	IP54/IP24
AC-WM4-15-4200	1500/1630 W	980 × 395 × 260 mm	230 VAC	50/60 Hz	Stainless steel	920 × 335 mm	IP54/IP24
AC-WM4-15-6200	1500 W	980 × 395 × 260 mm	400 VAC	50/60 Hz	Stainless steel	920 × 335 mm	IP54/IP24
AC-WM4-20-4200	2 000 W	980 × 395 × 260 mm	230 VAC	50/60 Hz	Stainless steel	920 × 335 mm	IP54/IP24
AC-WM4-20-6200	2 000 W	980 × 395 × 260 mm	400 VAC	50/60 Hz	Stainless steel	920 × 335 mm	IP54/IP24
AC-WM4-25-4200	2 500 W	1230 × 500 × 340 mm	230 VAC	50/60 Hz	Stainless steel	1130 × 430 mm	IP54/IP24
AC-WM4-25-6200	2 500 W	1230 × 500 × 340 mm	400 VAC	50/60 Hz	Stainless steel	1130 × 430 mm	IP54/IP24
AC-WM4-30-4200	3 000 W	1230 × 500 × 340 mm	230 VAC	50/60 Hz	Stainless steel	1130 × 430 mm	IP54/IP24
AC-WM4-30-6200	3 000 W	1230 × 500 × 340 mm	400 VAC	50/60 Hz	Stainless steel	1130 × 430 mm	IP54/IP24
AC-WM4-40-4200	4 000 W	1230 × 500 × 340 mm	230 VAC	50/60 Hz	Stainless steel	1130 × 430 mm	IP54/IP24
AC-WM4-40-6200	4 000 W	1230 × 500 × 340 mm	400 VAC	50/60 Hz	Stainless steel	1130 × 430 mm	IP54/IP24

* Other input voltage options available upon request.

Cooling units TOP (top mounting)

Code	Cooling capacity	Dimensions H × W × D	Voltage *	Frequency	Material	Cut-out dimensions	Degree of protection
AC-TM3-04-4200	450/460 W	230 × 430 × 330 mm	230 VAC	50/60 Hz	Stainless steel	142 × 98 mm/142 × 147,5 mm	IP54/IP24
AC-TM3-11-4200	1100/1150 W	400 × 600 × 400 mm	230 VAC	50/60 Hz	Stainless steel	108 × 530 mm (×2)	IP54/IP24
AC-TM3-11-6200	1100/1150 W	400 × 600 × 400 mm	400 VAC	50/60 Hz	Stainless steel	108 × 530 mm (×2)	IP54/IP24
AC-TM3-15-4200	1500 W	410 × 600 × 400 mm	230 VAC	50/60 Hz	Stainless steel	363 × 236.4 mm (×2)	IP54/IP24
AC-TM3-15-6200	1500 W	410 × 600 × 400 mm	400 VAC	50/60 Hz	Stainless steel	363 × 236.4 mm (×2)	IP54/IP24
AC-TM3-20-6200	2 000 W	410 × 600 × 400 mm	400 VAC	50/60 Hz	Stainless steel	363 × 236.4 mm (×2)	IP54/IP24

* Other input voltage options available upon request.

COOLING UNITS AIR FLOW

Cooling units—
wall-mounted

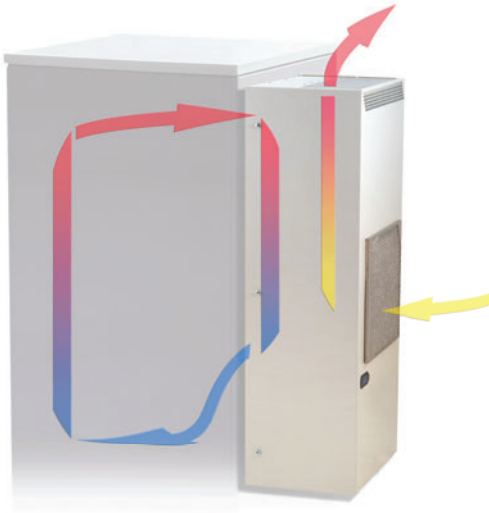

Cooling units—top

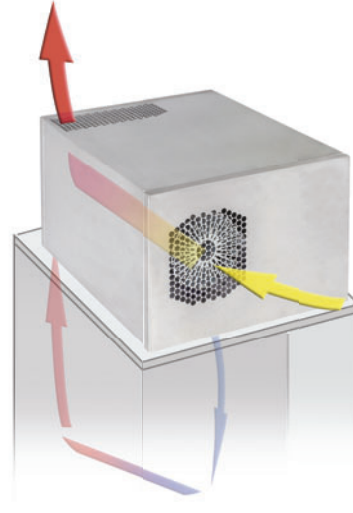

Fans—wall-mounted

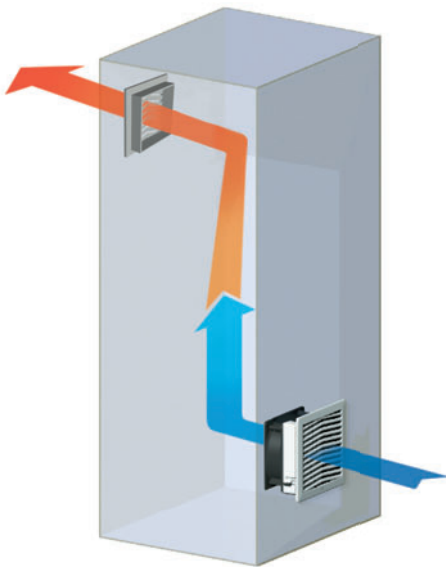

Fans—top

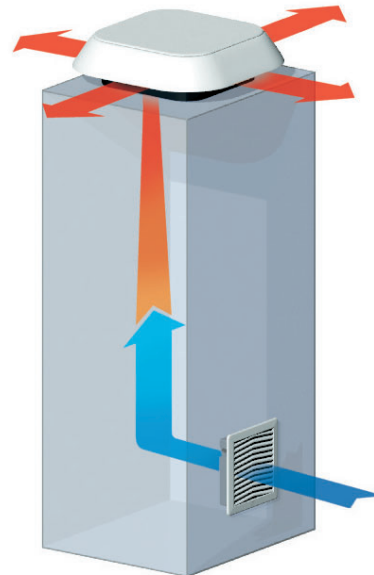

 For more detailed information, please refer to the product catalog "Climate control solutions" at www.conteg.com or contact our sales representatives.

FSM-O—FREE-STANDING COMPACT STAINLESS STEEL CABINETS

TECHNICAL DRAWINGS

FSM-O—free-standing compact outdoor cabinets—
stainless steel

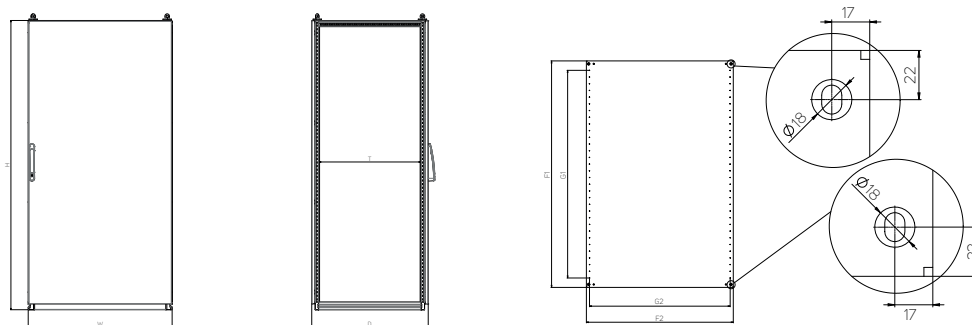

Code	Height (mm)	Width (mm)	Depth (mm)		Mounting plate (mm)				Material thickness (mm)			# of doors
	H *	W *	D *	T	F1	F2	G1	G2	Cabinet	Door	Mounting plate	
FSM-O-140603	1400	600	300	210	1291.2	497	1150	450	1.5	2	3	1
FSM-O-140604	1400	600	400	310	1291.2	497	1150	450	1.5	2	3	1
FSM-O-160604	1600	600	400	310	1491.2	497	1350	450	1.5	2	3	1
FSM-O-160803	1600	800	300	210	1491.2	697	1350	650	1.5	2	3	1
FSM-O-160804	1600	800	400	310	1491.2	697	1350	650	1.5	2	3	1
FSM-O-161003	1600	1000	300	210	1491.2	897	1350	850	1.5	2	3	1
FSM-O-161004	1600	1000	400	310	1491.2	897	1350	850	1.5	2	3	1
FSM-O-180604	1800	600	400	310	1691.2	497	1550	450	1.5	2	3	1
FSM-O-180803	1800	800	300	210	1691.2	697	1550	650	1.5	2	3	1
FSM-O-180804	1800	800	400	310	1691.2	697	1550	650	1.5	2	3	1
FSM-O-181004	1800	1000	400	310	1691.2	897	1550	850	1.5	2	3	1
FSM-O-200603	2000	600	300	210	1891.2	497	1750	450	1.5	2	3	1
FSM-O-200604	2000	600	400	310	1891.2	497	1750	450	1.5	2	3	1
FSM-O-200803	2000	800	300	210	1891.2	697	1750	650	1.5	2	3	1
FSM-O-200804	2000	800	400	310	1891.2	697	1750	650	1.5	2	3	1
FSM-O-200805	2000	800	500	410	1891.2	697	1750	650	1.5	2	3	1
FSM-O-201004	2000	1000	400	310	1891.2	897	1750	850	1.5	2	3	1

* Internal dimensions: H—90 mm, W—90 mm, D—90 mm.

HEAT LOSS DISPERSION

FSM-O—free-standing compact outdoor stainless steel cabinets—
measured with heat inside cabinet $\Delta T = 15\text{ K}$

Code	Cabinet dimensions (mm)			Thickness of the material (mm)		Number of doors (pcs)	Total area of cabinet (m ²)	Total power dissipation (W)
	Height	Width	Depth	Body	Door			
FSM-O-140603	1400	600	300	1.5	2.00	1	2.880	152.6
FSM-O-140604	1400	600	400	1.5	2.00	1	3.280	169.2
FSM-O-160604	1600	600	400	1.5	2.00	1	3.680	190.5
FSM-O-160803	1600	800	300	1.5	2.00	1	4.000	216.6
FSM-O-160804	1600	800	400	1.5	2.00	1	4.480	236.4
FSM-O-161003	1600	1000	300	1.5	2.00	1	4.760	260.8
FSM-O-161004	1600	1000	400	1.5	2.00	1	5.280	282.3
FSM-O-180604	1800	600	400	1.5	2.00	1	4.080	211.8
FSM-O-180803	1800	800	300	1.5	2.00	1	4.440	241.2
FSM-O-180804	1800	800	400	1.5	2.00	1	4.960	262.6
FSM-O-181004	1800	1000	400	1.5	2.00	1	5.840	313.4
FSM-O-200603	2000	600	300	1.5	2.00	1	3.960	211.7
FSM-O-200604	2000	600	400	1.5	2.00	1	4.480	233.2
FSM-O-200803	2000	800	300	1.5	2.00	1	4.880	265.8
FSM-O-200804	2000	800	400	1.5	2.00	1	5.440	288.9
FSM-O-200805	2000	800	500	1.5	2.00	1	6.000	312.0
FSM-O-201004	2000	1000	400	1.5	2.00	1	6.400	344.6

Do you need a customized solution?

Use services of our **CONTEG Modification Center**.

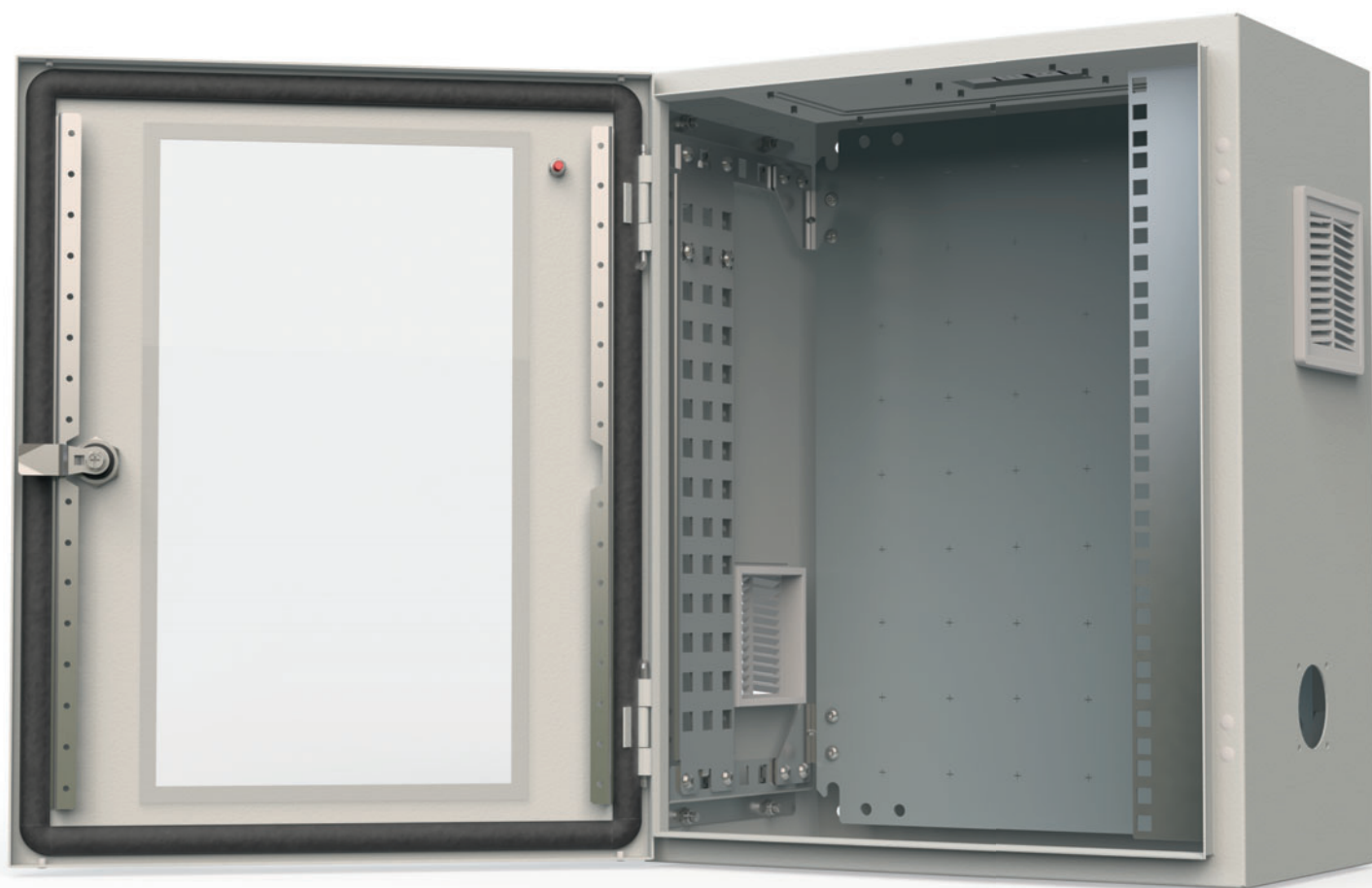

➤ Individual orders are fulfilled in the **modification center, which is a part of a modern industrial enterprise in Pelhrimov**. The center also has a MODCentrum 29 CNC milling machine. We can cut holes for filter fans, coolers, control panels, and buttons. The cabinets can be made of sheet steel, stainless steel (AISI 304 and 316L) or aluminum.

Cutouts can be made on flat removable parts of the rack walls (doors, cable entries, side panels, roofs and mounting plates), as well as in welded monolithic cabinets.



For more information please contact our sales or technical team at www.conteg.com/contacts



WME-O—
COMPACT
STAINLESS STEEL
OUTDOOR CABINETS



Main advantages and description	66
Accessories	68
Climate control solution—filter fans	74
Technical drawings	75
Heat loss dispersion	77

WME-O—COMPACT STAINLESS STEEL OUTDOOR CABINETS



WME-O-060604

➤ **WME-O compact stainless steel outdoor cabinets** with surface finish resistant to UV radiation are ideal for outdoor installations and can be equipped with e.g. a roof to protect them from rain and sun rays. The structural design of this series offers high rigidity of the entire cabinet and the back panel. Manufacturing by laser welding technology lends the cabinets a clean design. On request, CONTEG can also make cut-outs and perforations required for installation of equipment into cabinets.

MAIN ADVANTAGES

- Single-door cabinet
- The doors are fitted with a polyurethane foam seal all around the perimeter and a rotary lock or 3-point locking system from a height of 1 000 mm
- Perforated mounting rails on the doors of cabinets 500 mm in height and higher
- Perforated mounting rails on the side panels of cabinets 250 mm in depth and deeper
- Mounting plate with a marked raster 50 × 50 mm
- Accessories for wall-mounting
- Degree of protection IP66
- Left/right door hinge replacement

COLOR:  RAL 7035

DESCRIPTION

Material

- Cabinet: stainless steel 1.4016 (AISI 403), on request stainless steel 1.4301 (AISI 304)
- Mounting plate: zinc-plated sheet steel

Cabinet surface finish

- Polyester powder coating with UV protection

Color

- RAL 7035 for outdoor use

Degree of protection

- IP66 according to EN 60529 (the degree of protection may be reduced after mounting accessories)

Mechanical durability

- IK10 according to IEC 62262

Supply includes

- Single-door cabinet. The doors are equipped with a polyurethane foam seal all around the perimeter and a rotary lock or 3-point locking system from a height of 1 000 mm.
- Perforated mounting rails on the doors of cabinets 500 mm in height and higher.

- Perforated mounting rails on the sides of cabinets 250 mm in depth and deeper
- Mounting plate with a marked raster 50 × 50 mm
- Accessories for wall-mounting
- Clean design, without cable glands
- Cut outs for installation in the CONTEG Modification Center

WME-O—COMPACT STAINLESS STEEL OUTDOOR CABINETS, SINGLE DOOR, HEIGHT 300–500 MM

		300	300	300	400	400	400	500
Cabinet	H (mm)	300	300	300	400	400	400	500
	W (mm)	200	300	400	300	300	400	400
	D (mm)	155	210	210	155	210	210	210
Mounting plate	H1 (mm)	270	270	270	370	370	370	470
	W2 (mm)	150	250	350	250	250	350	350
Material thickness (mm)	Cabinet	1,25	1,25	1,25	1,25	1,25	1,25	1,25
	Door	1,5	1,5	1,5	1,5	1,5	1,5	1,5
	Mounting plate	2	2	2	2	2	2,5	2,5
Quantity	Hinges	2	2	2	2	2	2	2
	Cam locks	1	1	1	1	1	1	1
	Bolts	4	4	4	4	4	4	4
Weight (kg)		3,9	6,1	7,7	6,9	7,6	9,5	11,3
Code	1 pc	WME-O-030215	WME-O-030321	WME-O-030421	WME-O-040315	WME-O-040321	WME-O-040421	WME-O-050421
ACCESSORIES								
Door-mounting rails	1 pc	–	–	–	–	–	–	ID-W-VD4
Rain canopy	1 pc	ID-W-R2015	ID-W-R3020	ID-W-R4020	ID-W-R3015	ID-W-R3020	ID-W-R4020	ID-W-R4020
Pole mounting brackets	1 set	ID-W-MP2	ID-W-MP3	ID-W-MP4	ID-W-MP3	ID-W-MP3	ID-W-MP4	ID-W-MP4

WME-O—COMPACT STAINLESS STEEL OUTDOOR CABINETS , SINGLE DOOR, HEIGHT 500–800 MM									
Cabinet	H (mm)	500	500	600	600	600	600	800	
	W (mm)	500	500	400	600	600	600	600	
	D (mm)	210	300	300	210	300	400	250	
Mounting plate	H1 (mm)	470	470	570	570	570	570	770	
	W2 (mm)	450	450	350	550	550	550	550	
Material thickness (mm)	Cabinet	1,25	1,25	1,5	1,5	1,5	1,5	1,5	
	Door	1,5	1,5	1,5	1,5	1,5	1,5	2	
	Mounting plate	2,5	2,5	2,5	2,5	2,5	2,5	3 F *	
Quantity	Hinges	2	2	2	2	2	2	2	
	Cam lock	1	1	2	2	2	2	2	
	Bolts	4	4	4	4	4	4	4	
Weight (kg)		13,7	15,5	16,8	20,3	22,8	25,9	29,2	
Code		1 pc	WME-O-050521	WME-O-050503	WME-O-060403	WME-O-060621	WME-O-060603	WME-O-060604	WME-O-080625
ACCESSORIES									
Rails for interior installation		1 set	–	ID-W-H5	ID-W-H6	–	ID-W-H6	ID-W-H6	ID-W-H8
Door-mounting rails		1 set	ID-W-VD5	ID-W-VD5	ID-W-VD4	ID-W-VD6	ID-W-VD6	ID-W-VD6	ID-W-VD6
19" fixed extrusions		1 set	–	–	–	–	ID-W-U12	ID-W-U12	ID-W-U17
Plinth **	Front and rear	1 set	–	–	–	–	ID-W-SPF60	ID-W-SPF60	–
	Side	1 set	–	–	–	–	ID-W-SPS30	ID-W-SPS40	–
Rain canopy		1 pc	ID-W-R5020	ID-W-R5030	ID-W-R4030	ID-W-R6020	ID-W-R6030	ID-W-R6040	ID-W-R6025
Pole mounting brackets		1 set	ID-W-MP5	ID-W-MP5	ID-W-MP4	ID-W-MP6	ID-W-MP6	ID-W-MP6	ID-W-MP6

* 3 F—3 mm mounting plate with two bent edges.

** Plinth stainless steel, height 100 mm, RAL 7046.

WME-O—COMPACT STAINLESS STEEL OUTDOOR CABINETS , SINGLE DOOR, HEIGHT 800–1200 MM									
Cabinet	H (mm)	800	800	800	1000	1000	1200	1200	
	W (mm)	600	600	800	600	600	600	800	
	D (mm)	300	400	300	300	400	300	400	
Mounting plate	H1 (mm)	770	770	770	970	970	1170	1170	
	W2 (mm)	550	550	750	550	550	550	750	
Material thickness (mm)	Cabinet	1,5	1,5	1,5	1,5	1,5	1,5	1,5	
	Door	2	2	2	2	2	2	2	
	Mounting plate	3 F *	3 F *	3 FF *	3 F *	3 F *	3 F *	3 FF *	
Quantity	Hinges	2	2	2	3	3	3	3	
	Cam lock	2	2	2	–	–	–	–	
	3-point locking system	–	–	–	+	+	+	+	
	Bolts	4	4	4	4	4	6	6	
Weight (kg)		31,7	35,2	40,2	38,4	42,4	45	62	
Code		1 pc	WME-O-080603	WME-O-080604	WME-O-080803	WME-O-100603	WME-O-100604	WME-O-120603	WME-O-120804
ACCESSORIES									
Rails for interior installation		1 set	ID-W-H8	ID-W-H8	ID-W-H8	ID-W-H10	ID-W-H10	ID-W-H12	ID-W-H12
Door-mounting rails		1 set	ID-W-VD6	ID-W-VD6	ID-W-VD8	ID-W-VD6	ID-W-VD6	ID-W-VD6	ID-W-VD8
19" fixed extrusions		1 set	ID-W-U17	ID-W-U17	ID-W-U17 **	ID-W-U21	ID-W-U21	ID-W-U25	ID-W-U25 **
Plinth ***	Front and rear	1 set	ID-W-SPF60	ID-W-SPF60	ID-W-SPF80	ID-W-SPF60	ID-W-SPF60	ID-W-SPF60	ID-W-SPF80
	Side	1 set	ID-W-SPS30	ID-W-SPS40	ID-W-SPS30	ID-W-SPS30	ID-W-SPS40	ID-W-SPS30	ID-W-SPS40
Rain canopy		1 pc	ID-W-R6030	ID-W-R6040	ID-W-R8030	ID-W-R6030	ID-W-R6040	ID-W-R6030	ID-W-R8040
Pole mounting brackets		1 set	ID-W-MP6	ID-W-MP6	–	ID-W-MP6	ID-W-MP6	ID-W-MP6	–

* 3 F—3 mm mounting plate with two bent edges. 3 FF—3 mm mounting plate with four bent edges.

** Order also bracket ID-W-UB.

*** Plinth stainless steel, height 100 mm, RAL 7046.

ACCESSORIES

RAILS FOR INTERIOR INSTALLATION

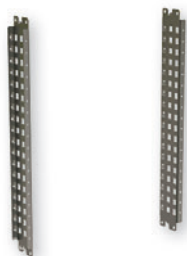

- Material: 2mm zinc-plated sheet steel with 25 mm perforation
- Rail width: 75 mm
- Mounting: onto interior rails, which are part of the cabinet
- Application: for distributors 250 mm deep and deeper and 400 mm in high and higher
- Supply includes: 2 mounting rails and accessories

Code	For cabinet height (mm)	Package *
ID-W-H5	500	1 set
ID-W-H6	600	1 set
ID-W-H7	700	1 set
ID-W-H8	800	1 set
ID-W-H10	1000	1 set
ID-W-H12	1200	1 set

* 1 set—2 pieces.

19" FIXED EXTRUSIONS



- Material: 2mm zinc-plated sheet steel
- Rail width: 56 mm
- Mounting: onto interior rails, which are part of the cabinet or onto the wall-mounting bracket ID-W-UD for cabinets 800 mm in width
- Application: for cabinets 250 mm deep and deeper and 600 and 800 mm wide
- Supply includes: 19" fixed extrusions and mounting accessories

Code	For cabinet height (mm)	Package *
ID-W-U12	600 (12U)	1 set
ID-W-U17	800 (17U)	1 set
ID-W-U21	1000 (21U)	1 set
ID-W-U25	1200 (25U)	1 set

* 1 set—2 pieces.

For cabinet width 800 mm, it's necessary to order the ID-W-UB wall-mounting brackets, packing contains 4 pcs.

DOOR-MOUNTING RAILS

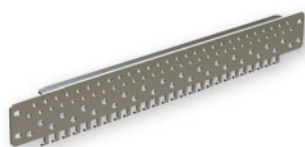

- Material: 2mm zinc-plated sheet steel
- Rail width: 61 mm (including door-mounting rails)
- Mounting: onto rails for interior installation, which are part of the cabinet door
- Application: for cabinets 500 mm high and higher
- Supply includes: 2 pcs door-mounting rails and mounting accessories

Code	For cabinet width (mm)	Package *
ID-W-VD3	300	1 set
ID-W-VD4	400	1 set
ID-W-VD5	500	1 set
ID-W-VD6	600	1 set
ID-W-VD8	800	1 set

* 1 set—2 pieces.

LOCKS/LOCK INSERTS



Double bar



Square



Triangular

Code	Typ	Package
ID-W-INLK	T handle with lock, key 5333, chrome-plated zamak	1 set*
ID-W-INLK1	Lock, key 444, chrome-plated zamak	1 set*
ID-W-INLK2	Lock, unique key, chrome-plated zamak	1 set*
ID-W-INLK3	Lock, key 5333, chrome-plated zamak	1 set*
ID-W-INLKE1	Zámek VM1, chrome-plated zamak	1 set*
ID-W-IND3	3 mm "Double bit", black zamak	1 pc
ID-W-IND5	5 mm "Double bar", black zamak	1 pc
ID-W-INS6	6 mm square, black zamak	1 pc
ID-W-INS7	7 mm square, black zamak	1 pc
ID-W-INS8	8 mm square, black zamak	1 pc
ID-W-INT7	7 mm triangular, black zamak	1 pc
ID-W-INT8	8 mm triangular, black zamak	1 pc
ID-W-INT9	9 mm triangular, black zamak	1 pc

* Complete set of metal lock with key.

WALL-MOUNTING BRACKETS



- Material: 3 mm stainless steel
- Load: 100 kg
- Package includes: wall-mounting brackets and all necessary assembly parts for mounting to the cabinet

Code	Package
ID-W-WB	4 pcs

PLINTH



- Height: 100 mm
- Material: 2 mm stainless steel 1.4016 (AISI 403)
- Surface finish: polyester powder coating
- Color: RAL 7046, RAL 7035
- For complete you have to order ID-W-SPSxx and ID-W-SPFxx
- Package includes: plinths and all necessary assembly parts

STAINLESS STEEL PLINTH—SIDE KIT

Code	For cabinet depth (mm)	Color	Package
ID-W-SPS30	300	RAL 7046	1 set
ID-W-SPS40	400	RAL 7046	1 set
ID-W-SPS30G	300	RAL 7035	1 set
ID-W-SPS40G	400	RAL 7035	1 set

1 set includes: 2× side part, mounting accessories.

STAINLESS STEEL PLINTH—FRONT AND REAR KIT

Code	For cabinet width (mm)	Color	Package
ID-W-SPF60	600	RAL 7046	1 set
ID-W-SPF80	800	RAL 7046	1 set
ID-W-SPF60G	600	RAL 7035	1 set
ID-W-SPF80G	800	RAL 7035	1 set

1 set includes: 1× front part, 1× rear part, mounting accessories.

RAIN CANOPY

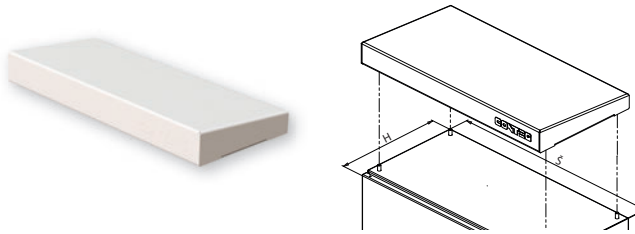

- Material: 2 mm aluminum sheet AlMg3
- Surface finish: polyester-powder coat
- Color: RAL 7035
- Mounting: direct on the top, 4× M6 screws
- Optional direction of the roof slope
- Cut-outs for installation in CONTEG Modification Center
- Package includes: rain canopy and all necessary assembly parts

Code	For cabinet W×D (mm)
ID-W-R2015	200 × 155
ID-W-R3015	300 × 155
ID-W-R3020	300 × 210
ID-W-R4015	400 × 155
ID-W-R4020	400 × 210
ID-W-R4030	400 × 300
ID-W-R5020	500 × 210
ID-W-R5030	500 × 300
ID-W-R6020	600 × 210
ID-W-R6025	600 × 250
ID-W-R6030	600 × 300
ID-W-R6040	600 × 400
ID-W-R8030	800 × 300
ID-W-R8040	800 × 400

POLE-MOUNTING BRACKETS



- Material: 2 mm stainless steel
- Installation: for poles with diameter up to 250 mm
- Load: 200 kg
- Package includes: pole-mounting brackets and all necessary assembly parts (2 profile rails, 2 clamping straps (l=850 mm), 8 set: screws M8×12, self-locking nuts and washers adhesion)

Code	For cabinet width (mm)
ID-W-MP2	200
ID-W-MP3	300
ID-W-MP4	400
ID-W-MP5	500
ID-W-MP6	600

DOOR STOP



- Material: 2 mm zinc-plated sheet steel
- Usage: available for cabinets of minimum height 500 mm and depth 250 mm
- Package includes: door stop and all necessary assembly parts

Code	Package
ID-W-DS	1 pc

DOOR SWITCH



- Material—brackets: 2 mm zinc-plated sheet steel
- Door switch: IP65, plastic, 1NO + 1 NC, PG13,5, -25 °C to +70 °C
- Usage: available for cabinets of minimum height 500 mm and depth 250 mm
- Package includes: door switch and all necessary assembly parts

Code	Package
ID-W-DC	1 pc

POCKET FOR DOCUMENTS



- Material: ABS
- Color: RAL 7035
- Dimensions: 234 × 241 × 31 mm (H × W × D)
- Mounting: with self-adhesive tape
- Package includes: plastic pocket for documents and adhesive tape

Code	Package
ID-PO-A4	1 pc

LIGHTING UNIT



- Protection degree: IP20
- Mounting: on mounting plate or inner side rails
- LED technology, 12 light spots
- Dimensions: 400 × 26 × 27 mm (W × H × D)
- Package includes: lighting unit and interconnection cables
- Bracket for installation on mounting plate. Depth adjustment is possible.

Code	Description	Package
ID-W-L	3W, 230 W, 50 Hz	1 pc

EARTHING



- ID-W-EK: complete earthing kit for cabinet
- ID-W-EW68/EW88/EW8816: 300 mm cable length with crimped lugs
- Set includes: nuts, screws for earthing door(s), cabinet and mounting plate

Code	Description	Package
ID-W-EK	Complete earthing kit WME	1 set *
ID-W-EW68	Grounding wires M6, M8 (door, cabinet), cross-section 10 mm ²	10 pc
ID-W-EW88	Grounding wires M8, M8 (cabinet, mounting plate), cross-section 10 mm ²	10 pc
ID-W-EW8816	Grounding wires M8, M8 (cabinet, mounting plate), cross-section 16 mm ²	10 pc

* Set includes: nuts, screws for earthing door(s), cabinet and mounting plate

BAYING KIT FOR INTEG WME



- Sealing material: polyethylene foam PNO1
- Sealing: 15 mm width and 10 mm thick
- Meets protection degree IP55
- Cutouts in CONTEG Modification Center
- Package includes: Baying kit and all necessary assembly parts

Code	Minimum dimensions of cabinet panel H × D (mm)	External dimension of gasket H × W (mm)	Maximal cut-out H × W (mm)	Package
ID-W-ROW4030	400 × 300	320 × 220	240 × 140	1 set
ID-W-ROW4040	400 × 400	320 × 320	240 × 240	1 set
ID-W-ROW6025	600 × 250	520 × 170	440 × 90	1 set
ID-W-ROW6030	600 × 300	520 × 220	440 × 140	1 set
ID-W-ROW6040	600 × 400	520 × 320	440 × 240	1 set
ID-W-ROW7025	700 × 250	620 × 170	540 × 90	1 set
ID-W-ROW7030	700 × 300	620 × 220	540 × 140	1 set
ID-W-ROW7040	700 × 400	620 × 320	540 × 240	1 set

CABLE GLANDS AND NUTS WITH PG/METRIC THREAD



- Material: polyamide PA6, sealing CR (neoprene)
- Protection degree: IP68
- Color: RAL 7035

Code	Description	Thread size	Ø cable (mm)	Package
ORO-PG7N	Cable entry Pg7	Pg7	2,5 – 6,5	10 pcs
ORO-PG9N	Cable entry Pg9	Pg9	3 – 8	5 pcs
ORO-PG11N	Cable entry Pg11	Pg11	4 – 10	5 pcs
ORO-PG13N	Cable entry Pg13	Pg13	5,5 – 12	5 pcs
ORO-PG16N	Cable entry Pg16	Pg16	8,5 – 14	5 pcs
ORO-PG21N	Cable entry Pg21	Pg21	11 – 18	5 pcs
ORO-PG29N	Cable entry Pg29	Pg29	17 – 25	5 pcs
ORO-PG36N	Cable entry Pg36	Pg36	22 – 33	1 pc
ORO-PG42N	Cable entry Pg42	Pg42	28 – 38	1 pc
ORO-PG48N	Cable entry Pg48	Pg48	32 – 44	1 pc
ORO-ZPG7N	Plastic nut Pg7	Pg7	–	10 pcs
ORO-ZPG9N	Plastic nut Pg9	Pg9	–	5 pcs
ORO-ZPG11N	Plastic nut Pg11	Pg11	–	5 pcs
ORO-ZPG13N	Plastic nut Pg13	Pg13	–	5 pcs
ORO-ZPG16N	Plastic nut Pg16	Pg16	–	5 pcs
ORO-ZPG21N	Plastic nut Pg21	Pg21	–	5 pcs
ORO-ZPG29N	Plastic nut Pg29	Pg29	–	5 pcs
ORO-ZPG36N	Plastic nut Pg36	Pg36	–	1 pc
ORO-ZPG42N	Plastic nut Pg42	Pg42	–	1 pc
ORO-ZPG48N	Plastic nut Pg48	Pg48	–	1 pc
ORO-M12N	Cable entry M12×1,5	M12×1,5	2,5 – 6,5	10 pcs
ORO-M16N	Cable entry M16×1,5	M16×1,5	4,5 – 10	5 pcs
ORO-M20N	Cable entry M20×1,5	M20×1,5	7 – 13	5 pcs
ORO-M25N	Cable entry M25×1,5	M25×1,5	10 – 17	5 pcs
ORO-M32N	Cable entry M32×1,5	M32×1,5	17 – 25	5 pcs
ORO-ZM12N	Plastic nut M12×1,5	M12×1,5	–	10 pcs
ORO-ZM16N	Plastic nut M16×1,5	M16×1,5	–	5 pcs
ORO-ZM20N	Plastic nut M20×1,5	M20×1,5	–	5 pcs
ORO-ZM25N	Plastic nut M25×1,5	M25×1,5	–	5 pcs
ORO-ZM32N	Plastic nut M32×1,5	M32×1,5	–	5 pcs

MEMBRANE ENTRY



- Material: polyamid/elastomer, UL-94 Vo, self-extinguishing
- Protection: IP64
- Instalation: cut-outs into cable glands
- Cut-outs for installation in CONTEG Modification Center
- Package includes: membrane 1 pc

Code	Dimensions W x D (mm)	Cables	Package
ID-W-ME24/19	142 × 44	12× max Ø 6,5 mm; 7× Ø 2,1 mm	1 pc
ID-W-ME24/48	142 × 44	48× max Ø 6,5 mm	1 pc

Do you need a customized solution?

Use services of our **CONTEG Modification Center**.



➤ Individual orders are fulfilled in the **modification center, which is a part of a modern industrial enterprise in Pelhrimov**. The center also has a MODCentrum 29 CNC milling machine. We can cut holes for filter fans, coolers, control panels, and buttons. The cabinets can be made of sheet steel, stainless steel (AISI 304 and 316L) or aluminum.

Cutouts can be made on flat removable parts of the rack walls (doors, cable entries, side panels, roofs and mounting plates), as well as in welded monolithic cabinets.



For more information please contact our sales or technical team at www.conteg.com/contacts

FILTER FANS



MAIN ADVANTAGES

- Quick assembly without screws and tools into a square cut-out, easy to mount with highly elastic clips
- Easy filter insert replacement from the outside without tools
- Possible to change airflow direction
- Airflow up to 800 m³/h
- Can be mounted in a cabinet with a sheet thickness of 1-2.5 mm
- IP 54 standard degree of protection
- Side and top ventilator placement
- Operating temperature range -10 °C up to +70 °C
- Polyurethane foam sealing around the whole perimeter
- Resistance against UV radiation
- Holes for installation in the CONTEG Modification Center

DESCRIPTION

- Plastic parts made of ABS/PC mix, all parts are self-extinguishing according to UL 94V-0
- Standard color RAL 7035 (different color on request)
- Filter inserts made of synthetic fibres of class G3 according to EN

- 779 and class G4 according to EN 779 and UL 900 class 2 self-extinguishing in class F1 according to DIN 53 438
- Filter inserts are cleaned by washing, compressed air and banging

- Encapsulated fan ball bearings
- IP54 standard degree of protection EN 60529 and NEMA 12 according to UL 50
- IP55 settable (according to EN 60529)

- IP56 when using protective cover against splashing water
- EMC version available on request

Fans

Code	Airflow	Dimensions H × W × D	Voltage **	Frequency	Outlet filter grid	Cut-out dimensions	Degree of protection
ID-EF-01-4	12/15 m ³ /h	106.5 × 106.5 × 59.9 mm	230 VAC	50/60 Hz	ID-EF-01	92 × 92 mm	IP54
ID-EF-01-1	15 m ³ /h	106.5 × 106.5 × 59.9 mm	24 VDC	–	ID-EF-01	92 × 92 mm	IP54
ID-EF-04-4	45/50 m ³ /h	150 × 150 × 65.5 mm	230 VAC	50/60 Hz	ID-EF-03	125 × 125 mm	IP54
ID-EF-04-1	47 m ³ /h	150 × 150 × 65.5 mm	24 VDC	–	ID-EF-03	125 × 125 mm	IP54
ID-EF-10-4	100/110 m ³ /h	203.9 × 203.9 × 87.5 mm	230 VAC	50/60 Hz	ID-EF-05	177 × 177 mm	IP54
ID-EF-10-1	100 m ³ /h	203.9 × 203.9 × 87.5 mm	24 VDC	–	ID-EF-05	177 × 177 mm	IP54
ID-EF-23-4	230/270 m ³ /h	250 × 250 × 115.3 mm	230 VAC	50/60 Hz	ID-EF-07	223 × 223 mm	IP54
ID-EF-22-1	225 m ³ /h	250 × 250 × 115.3 mm	24 VDC	–	ID-EF-07	223 × 223 mm	IP54
ID-EF-52-4	520/580 m ³ /h	325 × 325 × 150.7 mm	230 VAC	50/60 Hz	ID-EF-09	291 × 291 mm	IP54
ID-EF-71-4	710/800 m ³ /h	325 × 325 × 149 mm	230 VAC	50/60 Hz	ID-EF-09	291 × 291 mm	IP54
ID-EFT-42-4 *	420/490 m ³ /h	324 × 324 × 94 mm	230 VAC	50/60 Hz	ID-EF-09	fan 175 × 175 mm/grid 291 × 291 mm	IP54
ID-EO-TC	Thermostat for cooling	55 × 33 × 43 mm	250 VAC/10 A	–	–	–	IP20

* Top version.

** Other input voltage options available upon request.

For more detailed information, please refer to the product catalog "Climate control solutions" at www.conteg.com or contact our sales representatives.

TECHNICAL DRAWINGS

WME-O—compact stainless steel outdoor cabinets—
single-door with one cam lock

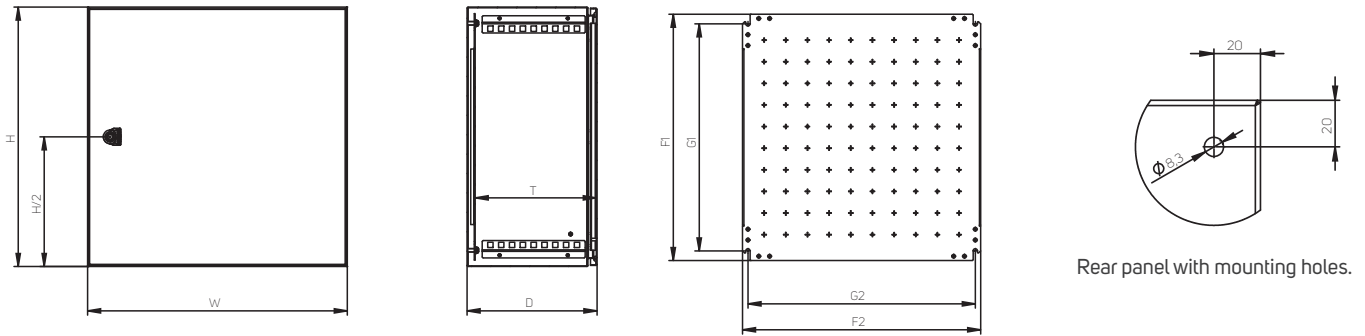

Code	Height (mm)		Width (mm)		Depth (mm)		Mounting plate (mm)				Material thickness (mm)		
	H	W	D	T*	F1	F2	G1	G2	Cabinet	Door	Mounting plate		
WME-O-030215	300	200	155	135	270	150	225	125	1,25	1,5	2,0		
WME-O-030321	300	300	210	190	270	250	225	225	1,25	1,5	2,0		
WME-O-030421	300	400	210	190	270	350	225	325	1,25	1,5	2,0		
WME-O-040315	400	300	155	135	370	250	325	225	1,25	1,5	2,0		
WME-O-040321	400	300	210	190	370	250	325	225	1,25	1,5	2,0		
WME-O-040421	400	400	210	190	370	350	325	325	1,25	1,5	2,5		
WME-O-050421	500	400	210	190	470	350	425	325	1,25	1,5	2,5		
WME-O-050521	500	500	210	190	470	450	425	425	1,25	1,5	2,5		
WME-O-050503	500	500	300	280	470	450	425	425	1,25	1,5	2,5		
WME-O-060403	600	400	300	280	570	350	525	325	1,50	2,0	2,5		
WME-O-060621	600	600	210	190	570	550	525	525	1,50	2,0	2,5		
WME-O-060603	600	600	300	280	570	550	525	525	1,50	2,0	2,5		
WME-O-060604	600	600	400	380	570	550	525	525	1,50	2,0	2,5		

* T indicates the depth between the mounting plate and the inside of the door, door trim reduces this value by 17 mm and lock by 31 mm.

WME-O—compact stainless steel outdoor cabinets—
single-door with two cam locks

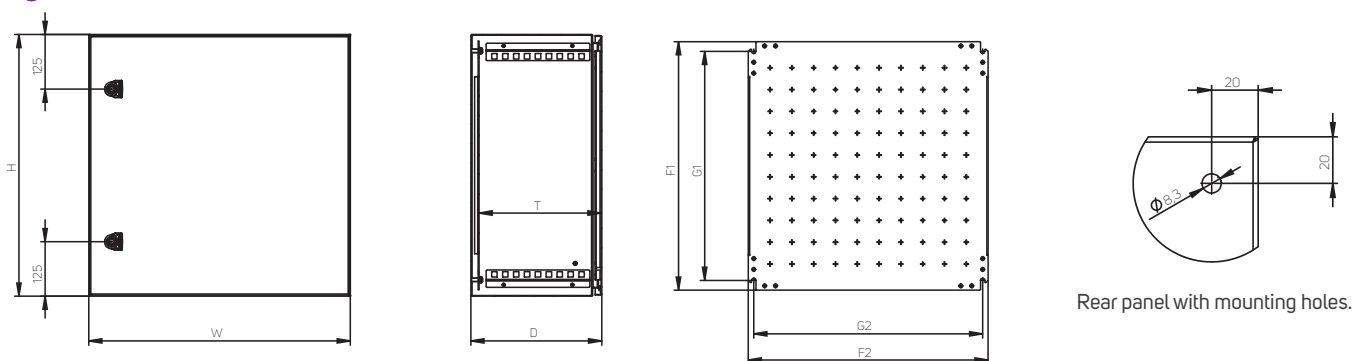

Code	Height (mm)		Width (mm)		Depth (mm)		Mounting plate (mm)				Material thickness (mm)		
	H	W	D	T***	F1	F2	G1	G2	Cabinet	Door	Mounting plate		
WME-O-080625	800	600	250	230	770	550	725	525	2,0	2,0	3 F*		
WME-O-080603	800	600	300	280	770	550	725	525	2,0	2,0	3 F*		
WME-O-080604	800	600	400	380	770	550	725	525	2,0	2,0	3 F*		
WME-O-080803	800	800	300	280	770	750	725	725	2,0	2,0	3 FF**		

* 3 F—3 mm mounting plate with 2 bent edges. ** 3 FF—3 mm mounting plate with 4 bent edges.

*** T indicates the depth between the mounting plate and the inside of the door, door trim reduces this value by 17 mm and lock by 31 mm.

WME-O—compact stainless steel outdoor cabinets— single-door with 3-point lock system

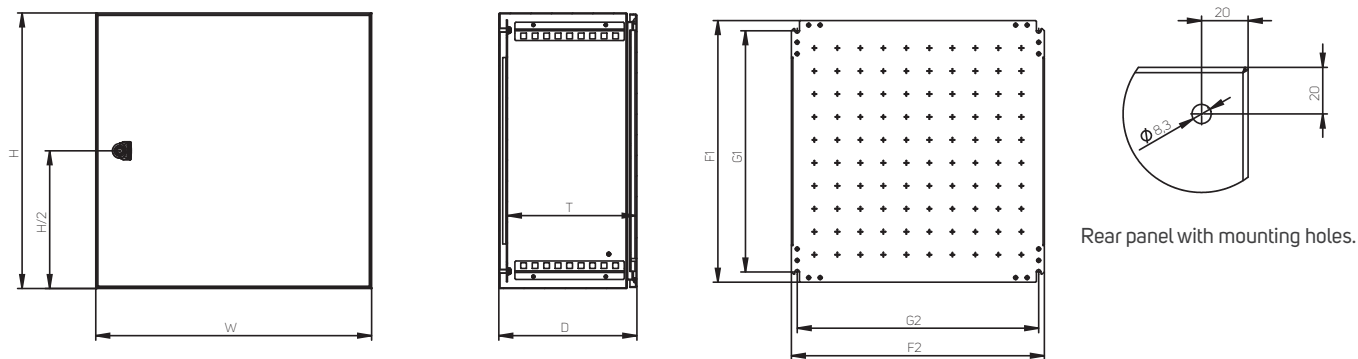

Rear panel with mounting holes.

Code	Height (mm)		Width (mm)		Depth (mm)		Mounting plate (mm)				Material thickness (mm)		
	H	W	D	T***	F1	F2	G1	G2	Cabinet	Door	Mounting plate		
WME-O-100603	1000	600	300	280	970	550	925	525	2,0	2,0	3 F*		
WME-O-100604	1000	600	400	380	970	550	925	525	2,0	2,0	3 F*		
WME-O-120603	1200	600	300	280	1170	550	1125	525	2,0	2,0	3 F*		
WME-O-120804	1200	800	400	380	1170	750	1125	725	2,0	2,0	3 FF**		

* 3 F—3 mm mounting plate with 2 bent edges.

** 3 FF—3 mm mounting plate with 4 bent edges.

*** T indicates the depth between the mounting plate and the inside of the door, door trim reduces this value by 17 mm and lock by 31 mm.

HEAT LOSS DISPERSION

WME-O—compact stainless steel outdoor cabinets,
measuring inside cabinets, $\Delta T = 15 \text{ K}$

Code	H (mm)	W (mm)	D (mm)	Thickness of material (mm)		Surface (m ²)	Effective area without rear panel (m ²)	Heating dissipation (W)
				Body	Door			
WME-O-030215	300	200	155	1,25	1,50	0,275	0,215	14,0
WME-O-030321	300	300	210	1,25	1,50	0,432	0,342	21,8
WME-O-030421	300	400	210	1,25	1,50	0,534	0,414	27,3
WME-O-040315	400	300	155	1,25	1,50	0,457	0,337	24,1
WME-O-040321	400	300	210	1,25	1,50	0,534	0,414	27,3
WME-O-040421	400	400	210	1,25	1,50	0,656	0,496	34,1
WME-O-050421	500	400	210	1,25	1,50	0,778	0,578	40,8
WME-O-050521	500	500	210	1,25	1,50	0,920	0,670	48,8
WME-O-050503	500	500	300	1,25	1,50	1,100	0,850	56,4
WME-O-060403	600	400	300	1,50	1,50	1,080	0,840	54,5
WME-O-060621	600	600	210	1,50	1,50	1,224	0,864	65,4
WME-O-060603	600	600	300	1,50	1,50	1,440	1,080	74,3
WME-O-060604	600	600	400	1,50	1,50	1,680	1,320	84,2
WME-O-080625	800	600	250	1,50	2,00	1,660	1,180	87,8
WME-O-080603	800	600	300	1,50	2,00	1,800	1,320	93,6
WME-O-080604	800	600	400	1,50	2,00	2,080	1,600	105,2
WME-O-080803	800	800	300	1,50	2,00	2,240	1,600	118,2
WME-O-100603	1000	600	300	1,50	2,00	2,160	1,560	113,3
WME-O-100604	1000	600	400	1,50	2,00	2,480	1,880	126,5
WME-O-120603	1200	600	300	1,50	2,00	2,520	1,800	133,0
WME-O-120804	1200	800	400	1,50	2,00	3,520	2,560	183,9



CONTEG, spol. s r.o.

Headquarters:

Na Vitezne plani 1719/4
140 00 Prague 4
Czech Republic

Tel.: +420 565 300 362

conteg@conteg.com

www.conteg.com